

## Macizos y Tubos cuadrados y rectangulares con aristas trabajadas

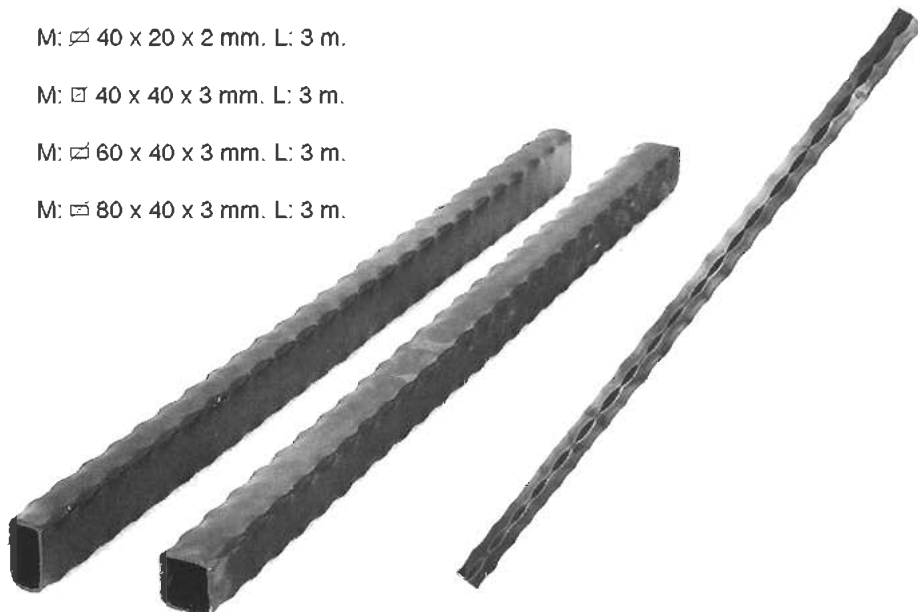

### “ TUBOS ”

- 4-9270 M:  $\square$  20 x 20 x 2 mm. L: 3 m.
- 4-9272 M:  $\square$  30 x 30 x 2 mm. L: 3 m.
- 4-9273 M:  $\square$  40 x 20 x 2 mm. L: 3 m.
- 4-9274 M:  $\square$  40 x 40 x 3 mm. L: 3 m.
- 4-9276 M:  $\square$  60 x 40 x 3 mm. L: 3 m.
- 4-9278 M:  $\square$  80 x 40 x 3 mm. L: 3 m.



### “ MACIZOS ”

- 4-8202  
M:  $\square$  12 x 12 mm. L: 3 m.
- 4-9200  
M:  $\square$  14 x 14 mm. L: 3 m.
- 4-9202  
M:  $\square$  16 x 16 mm. L: 3 m.
- 4-9204  
M:  $\square$  20 x 20 mm. L: 3 m.
- 4-9206  
M:  $\square$  25 x 25 mm. L: 3 m.

## Barras salomónicas a 3 y 6 metros



- 4-8257 M:  $\square$  12 mm. L: 3 m.
- 4-8257.6 M:  $\square$  12 mm. L: 6 m.
- 4-9255 M:  $\square$  14 mm. L: 3 m.
- 4-9255.6 M:  $\square$  14 mm. L: 6 m.



- 4-9257 M:  $\square$  16 mm. L: 3 m.
- 4-9257.6 M:  $\square$  16 mm. L: 6 m.
- 4-9259 M:  $\square$  20 mm. L: 3 m.
- 4-9259.6 M:  $\square$  20 mm. L: 6 m.

# Barras transversales



Distancia entre agujeros: 110 mm.

- 4-7032 M: 40 x 8 mm. taladro de 12 mm. L: 3 m.
- 4-7034 M: 40 x 8 mm. taladro de 14 mm. L: 3 m.
- 4-7036 M: 40 x 8 mm. taladro de 16 mm. L: 3 m.
- 4-7038 M: 40 x 8 mm. taladro de 20 mm. L: 3 m.



Distancia entre agujeros: 110 mm.

- 4-8032 M: 40 x 8 mm. taladro de 12 mm. L: 3 m.
- 4-8034 M: 40 x 8 mm. taladro de 14 mm. L: 3 m.
- 4-8036 M: 40 x 8 mm. taladro de 16 mm. L: 3 m.
- 4-8038 M: 40 x 8 mm. taladro de 20 mm. L: 3 m.



Distancia entre agujeros: 110 mm.

- 4-6032 M:  $\varnothing$  12 - L: 3 m.
- 4-6034 M:  $\varnothing$  14 - L: 3 m.
- 4-6036 M:  $\varnothing$  16 - L: 3 m.
- 4-6038 M:  $\varnothing$  18 - L: 3 m.

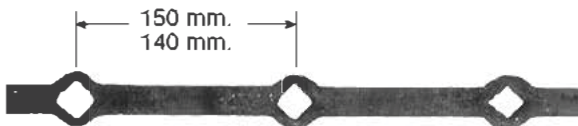

- 4-8046 Barra 13 agujeros  
M:  $\square$  16 mm. Taladro plano. L: 2 m.
- 4-8046.14 Barra 14 agujeros  
M:  $\square$  14 mm. Taladro plano. L: 2 m.

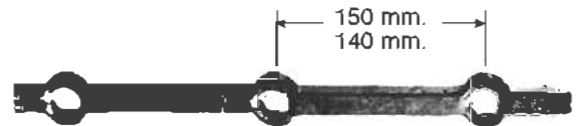

- 4-8047 Barra 13 agujeros  
M:  $\square$  16 mm. Taladro plano. L: 2 m.
- 4-8047.14 Barra 14 agujeros  
M:  $\square$  14 mm. Taladro plano. L: 2 m.



- 4-8048 Barra 13 agujeros  
M:  $\square$  16 mm. Taladro sobre arista. L: 2 m.

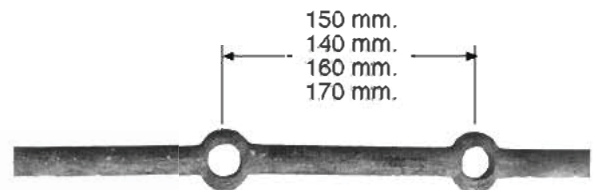

- 4-8056 M:  $\varnothing$  16 - L: 2 m. 13 agujeros
- 4-8056.14 M:  $\varnothing$  14 - Agujero 14 mm. L: 2 m. 14 agujeros
- 4-8056.18 M:  $\varnothing$  18 - Agujero 18 mm. L: 2 m. 12 agujeros
- 4-8056.20 M:  $\varnothing$  20 - Agujero 20 mm. L: 2 m. 11 agujeros

# Pasamanos

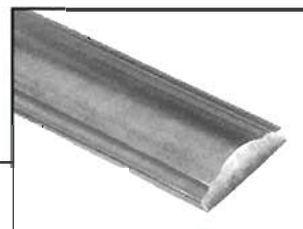

**4-8441**  
M:  $\varnothing$  50 x 15 mm. L: 3 m.  
**4-8445**  
M:  $\varnothing$  60 x 16 mm. L: 3 m.



**4-8440.12** M:  $\varnothing$  50 x 12 mm. L: 3 m.  
**4-8440** M:  $\varnothing$  50 x 10 mm. L: 3.3 m.  
**4-8440.1** M:  $\varnothing$  40 x 8 mm. L: 3 m.  
**4-8440.2** M:  $\varnothing$  30 x 8 mm. L: 3 m.  
**4-9159** M:  $\varnothing$  21 x 6 mm. L: 4 m.  
**4-8159** M:  $\varnothing$  14 x 4 mm. L: 4 m.



**4-8452**  
M:  $\square$  40 x 8 mm. L: 3 m. "Flor"

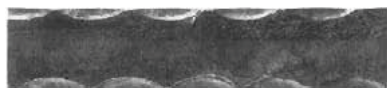

**4-8454**  
M:  $\square$  40 x 8 mm. L: 3 m. "Cantos"  
**4-8442**  
M:  $\square$  25 x 8 mm. L: 3 m. "Cantos"

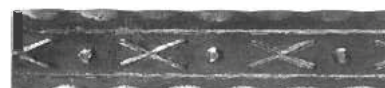

**4-8453**  
M:  $\square$  40 x 8 mm. L: 3 m. "Cruz"



**4-8455**  
M:  $\square$  40 x 8 mm. L: 3 m. "Rayas"



**4-8456**  
M:  $\square$  40 x 8 mm. L: 3 m. "Rayas"



**4-8443**  
M:  $\square$  45 x 16 mm. L: 3 m.

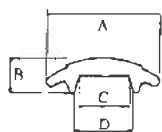

A: 45 mm.  
B: 16 mm.  
C: 22 mm.  
D: 24 mm.



**4-8446**  
M:  $\square$  25 x 8 mm. L: 3 m. "Liso"  
**4-8449**  
M:  $\square$  40 x 8 mm. L: 3 m. "Liso"



**4-8444**  
M:  $\square$  44 x 14 mm. L: 3 m.

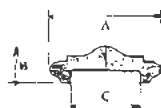

A: 44 mm.  
B: 14 mm.  
C: 27,5 mm.

# Accesorios pasamanos

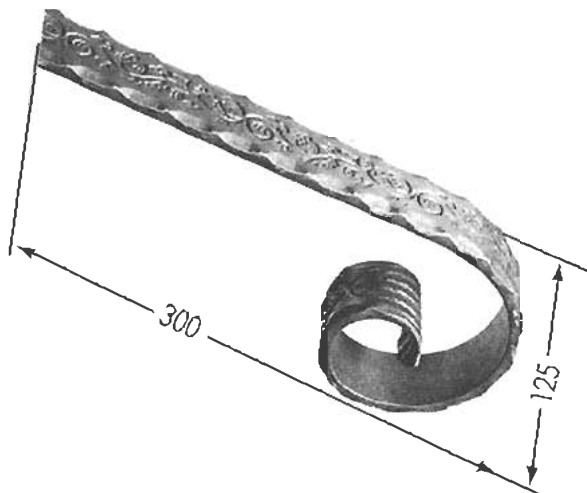

**4-8439**  
M:  $\varnothing$  50 x 10 mm.  
(para 4-8440)

**4-8438**  
M:  $\varnothing$  40 x 8 mm.  
(para 4-8440.1)

**4-8437**  
M:  $\varnothing$  30 x 8 mm.  
(para 4-8440.2)

**4-8436**  
M:  $\varnothing$  50 x 12 mm.  
(para 4-8440.12)

**4-8187**  
M:  $\varnothing$  40 x 8 mm.  
(para 4-8455)

**4-8188**  
M:  $\varnothing$  40 x 8 mm.  
(para 4-8456)

**4-8183**  
M:  $\varnothing$  40 x 8 mm.  
(para 4-8452)

**4-8184**  
M:  $\varnothing$  40 x 8 mm.  
(para 4-8453)

**4-8185**  
M:  $\varnothing$  40 x 8 mm.  
(para 4-8454)

**4-8186**  
M:  $\varnothing$  40 x 8 mm.  
(para 4-8449)

**4-8484**  
M:  $\varnothing$  50 x 15 mm.  
(para 4-8441)

**4-8440.T** M:  $\varnothing$  50 x 10 mm.  
(para 4-8440)

**4-8440.1.T** M:  $\varnothing$  40 x 8 mm.  
(para 4-8440.1)

**4-8440.2.T** M:  $\varnothing$  30 x 8 mm.  
(para 4-8440.2)

**4-8440.12.T** M:  $\varnothing$  50 x 12 mm.  
(para 4-8440.12)

**4-8441.T** M:  $\varnothing$  50 x 15 mm.  
(para 4-8441)

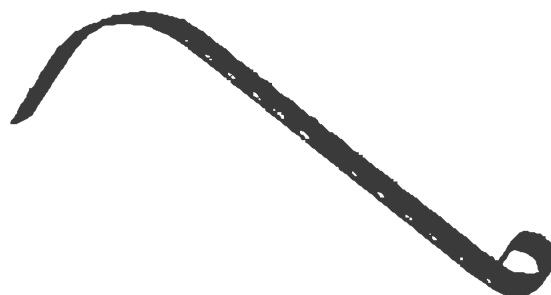

**4-2179** M:  $\varnothing$  40 x 8 mm.  
(para 4-8452)

**4-2178** M:  $\varnothing$  40 x 8 mm.  
(para 4-8453)

**4-2177** M:  $\varnothing$  40 x 8 mm.  
(para 4-8454)

**4-2176** M:  $\varnothing$  40 x 8 mm.  
(para 4-8456)

**4-2169** M:  $\varnothing$  40 x 8 mm.  
(para 4-8449)

**4-2159** M:  $\varnothing$  40 x 8 mm.  
(para 4-8455)

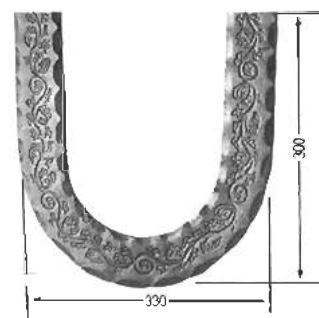
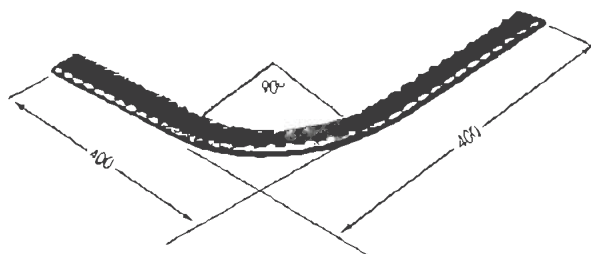

**4-8174** M:  $\varnothing$  40 x 8 mm. Para 4-8452

**4-8175** M:  $\varnothing$  40 x 8 mm. Para 4-8454

**4-8176** M:  $\varnothing$  40 x 8 mm. Para 4-8453

**4-8177** M:  $\varnothing$  40 x 8 mm. Para 4-8449

**4-8178** M:  $\varnothing$  40 x 8 mm. Para 4-8455

**4-8171** M:  $\varnothing$  40 x 8 mm. Para 4-8456

**4-8179** M:  $\varnothing$  40 x 8 mm. Para 4-8449

**4-8180** M:  $\varnothing$  40 x 8 mm. Para 4-8452

**4-8181** M:  $\varnothing$  40 x 8 mm. Para 4-8453

**4-8182** M:  $\varnothing$  40 x 8 mm. Para 4-8454

**4-8155** M:  $\varnothing$  40 x 8 mm. Para 4-8455

**4-8156** M:  $\varnothing$  40 x 8 mm. Para 4-8456

# Accesorios pasamanos

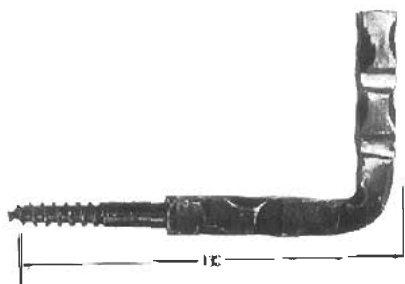

**4-8410**  
M  $\square$  :14 x 14 mm. L: 130 mm.



**4-8412**  
M  $\square$  :12 x 12 mm. L: 170 mm.



**4-2171**  
M  $\square$  :12 x 12 mm. L: 160 mm.



**4-2173**  
M  $\square$  :12 x 12 mm. L: 160 mm.



**4-8414**  
M  $\square$  :12 x 12 mm. 92 mm.

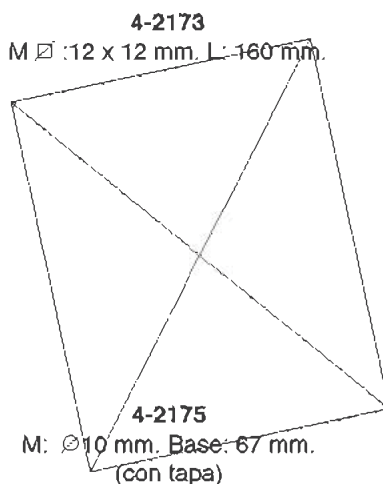

**4-1171**  
M: 140 x 100 mm.



**4-1173**  
M: 220 mm.

## Barros iniciales o intermedios



**4-2250**  
L: 1.200 mm.  
Ø 20 mm.



**4-2252**  
L: 1.200 mm.  
Ø 20 mm.



**4-2251**  
L: 1.200 mm.  
Ø 20 mm.



**4-2196**  
L: 1.200 mm.  
Ø 25 mm.



**4-2195**  
L: 1.200 mm.  
Ø 25 mm.



**4-8292**  
L: 1.200 mm.  
Ø 25 mm.



**4-2199**  
L: 1.200 mm.  
Ø 25 mm.

**4-3055**  
L: 1.200 mm.  
Ø 30 mm.

**4-6257**  
L: 1.200 mm.  
Ø 30 mm.

**4-8292.1**  
L: 1.200 mm.  
Ø 30 mm.

**4-4055**  
L: 1.200 mm.  
Ø 40 mm.

## Barros iniciales o intermedios



**4-5000**  
L: 1.200 mm.  
Ø 20 mm.



**4-2000**  
L: 1.200 mm.  
Ø 20 mm.

**4-3000**  
L: 1.200 mm.  
Ø 30 mm.



**4-2201**  
L: 1.200 mm.  
Ø 20 mm.



**4-2200**  
L: 1.200 mm.  
Ø 20 mm.

**4-6200**  
L: 1.200 mm.  
Ø 25 mm.

**4-6202**  
L: 1.200 mm.  
Ø 30 mm.



**4-6201**  
L: 1.200 mm.  
Ø 30 mm.

# Barrotes de relleno

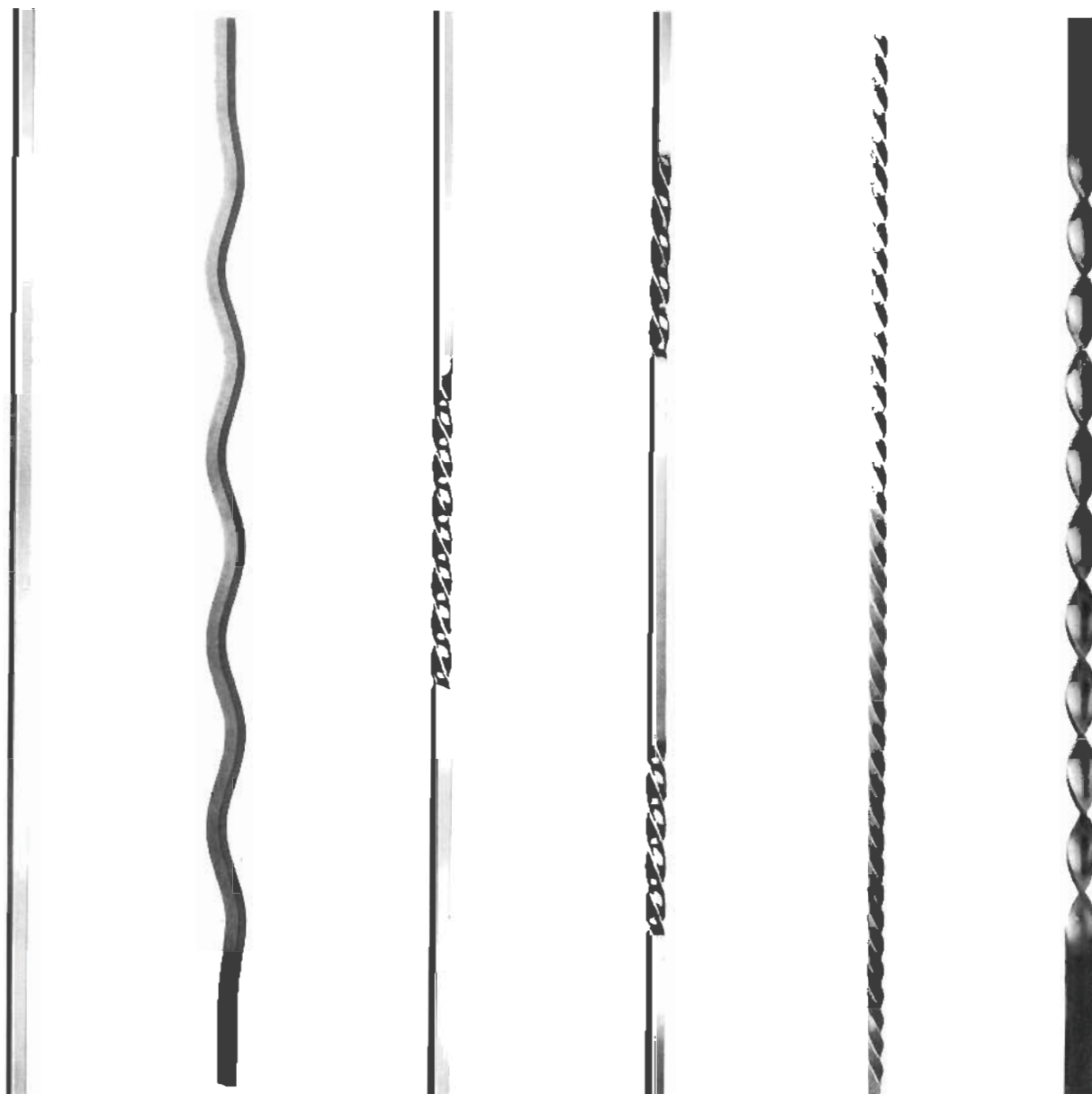

**4-2203**  
L: 950 mm.  
Ø 12 mm.

**4-2259**  
L: 950 mm.  
Ø 14 mm.

**4-2255**  
L: 950 mm.  
Ø 12 mm.

**4-2258**  
L: 950 mm.  
Ø 12 mm.

**4-2257**  
L: 950 mm.  
Ø 12 mm.

**4-2260**  
☑ Pletina rizada  
(sobre pedido)

**4-2205**  
L: 950 mm.  
Ø 14 mm.

**4-5255**  
L: 950 mm.  
Ø 14 mm.

**4-5258**  
L: 950 mm.  
Ø 14 mm.

**4-4257**  
L: 950 mm.  
Ø 14 mm.

**4-3203**  
L: 1.200 mm.  
Ø 16 mm.

**4-3255**  
L: 1.200 mm.  
Ø 16 mm.

**4-3258**  
L: 1.200 mm.  
Ø 16 mm.

**4-3257**  
L: 1.200 mm.  
Ø 16 mm.

**4-2204**  
L: 1.200 mm.  
Ø 20 mm.

• Previa consulta, los barrotes pueden fabricarse a medida.



# Barrotes decorativos

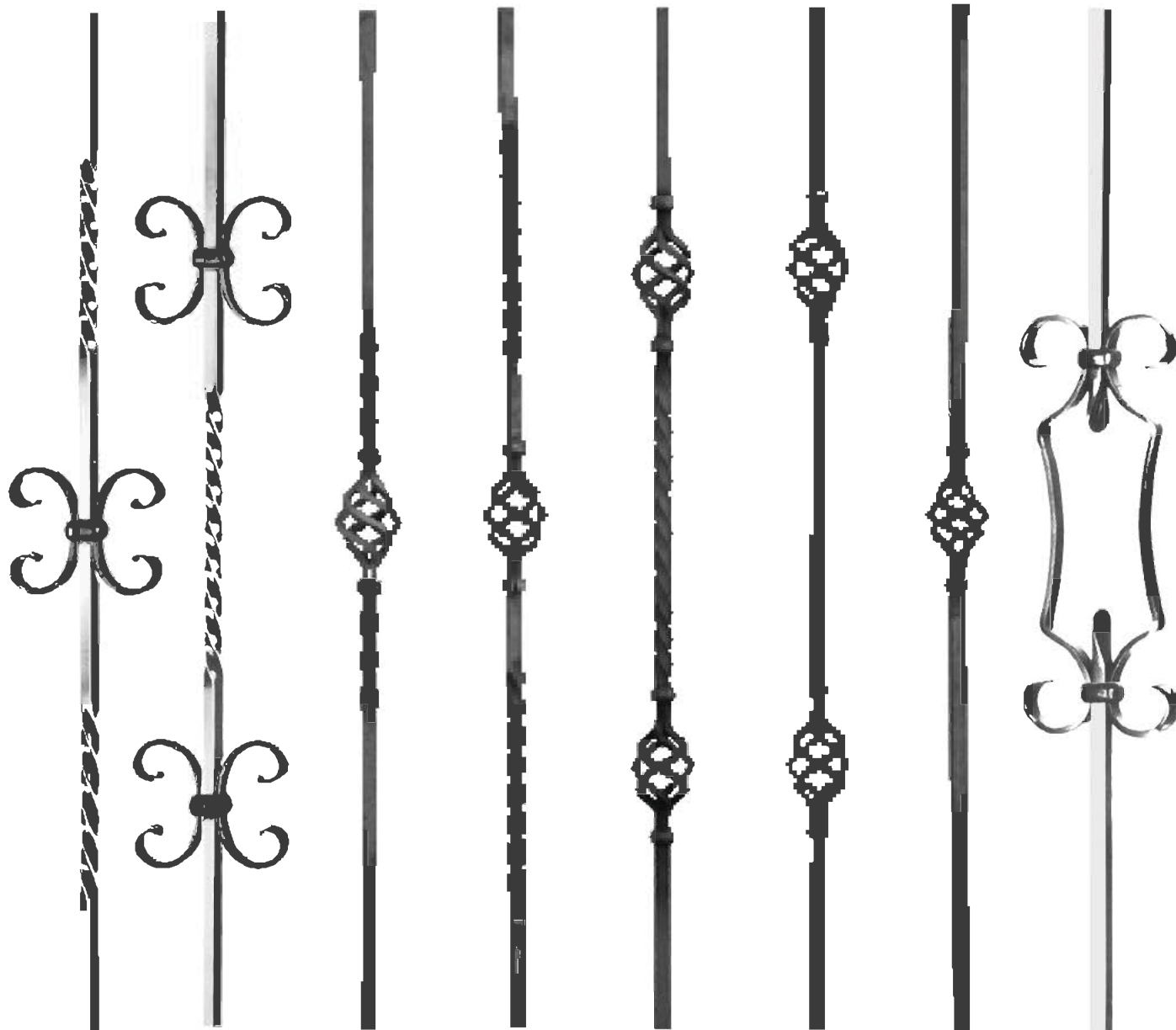

<b>4-2253</b> L: 950 mm. Ø 12 mm.	<b>4-2256</b> L: 950 mm. Ø 12 mm.	<b>4-2025</b> L: 950 mm. Ø 12 mm.	<b>4-2025.S</b> L: 950 mm. Ø 12 mm.	<b>4-2026</b> L: 950 mm. Ø 12 mm.	<b>4-2026.L</b> L: 950 mm. Ø 12 mm.	<b>4-2225</b> L: 950 mm. Ø 12 mm.	<b>4-2028</b> L: 950 mm. Ø 12 mm.
<b>4-5253</b> L: 950 mm. Ø 14 mm.	<b>4-5256</b> L: 950 mm. Ø 14 mm.	<b>4-4025</b> L: 950 mm. Ø 14 mm.	<b>4-4025.S</b> L: 950 mm. Ø 14 mm.	<b>4-4026</b> L: 950 mm. Ø 14 mm.	<b>4-4026.L</b> L: 950 mm. Ø 14 mm.	<b>4-4225</b> L: 950 mm. Ø 14 mm.	<b>4-3028</b> L: 1.200 mm. Ø 16 mm.
<b>4-3253</b> L: 1.200 mm. Ø 16 mm.	<b>4-3256</b> L: 1.200 mm. Ø 16 mm.	<b>4-3025</b> L: 1.200 mm. Ø 16 mm.	<b>4-3025.S</b> L: 1.200 mm. Ø 16 mm.	<b>4-3026</b> L: 1.200 mm. Ø 16 mm.	<b>4-3026.L</b> L: 1.200 mm. Ø 16 mm.	<b>4-3225</b> L: 1.200 mm. Ø 16 mm.	

## Barrotes decorativos

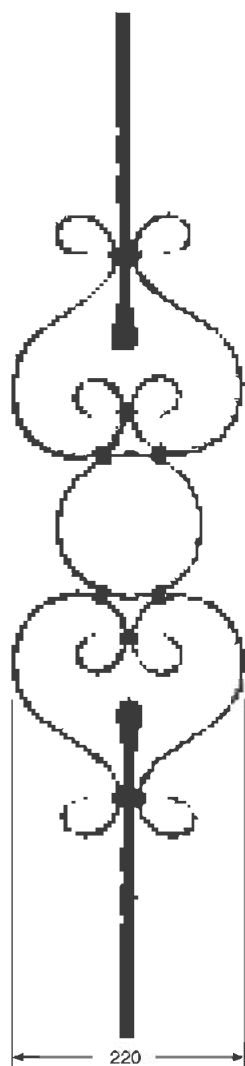

**4-2235**  
L: 950 mm.  
∅ 12 mm.

**4-3235**  
L: 1.200 mm.  
∅ 16 mm.

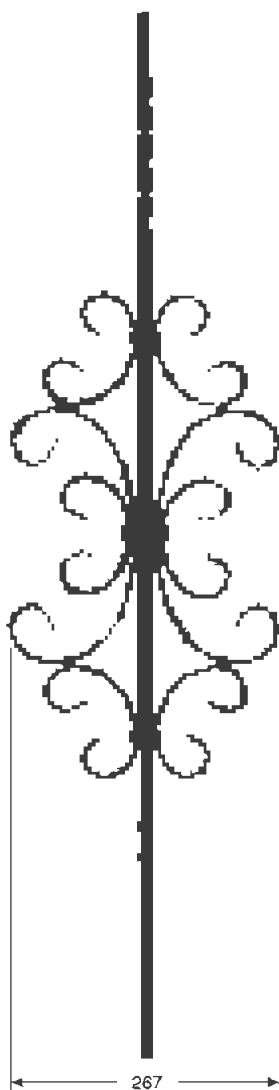

**4-2236**  
L: 950 mm.  
∅ 12 mm.

**4-3236**  
L: 1.200 mm.  
∅ 16 mm.

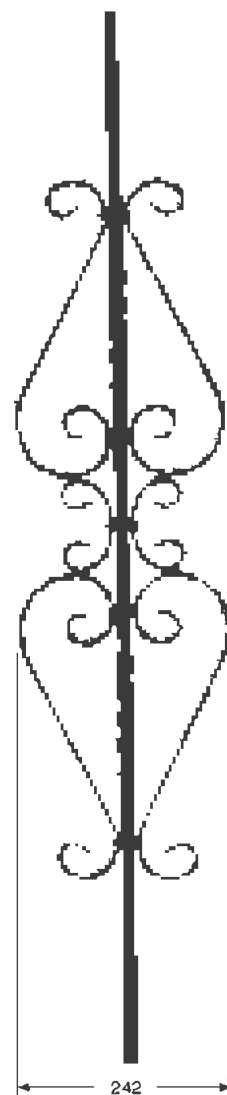

**4-3296**  
L: 1.200 mm.  
∅ 16 mm.

# Barrotes decorativos



**4-2005**  
L: 950 mm.  
∅ 12 mm.



**4-2008**  
L: 950 mm.  
∅ 12 mm.

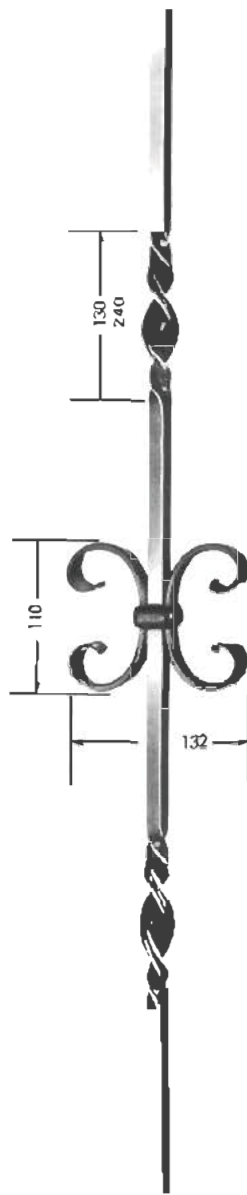

**4-2013**  
L: 950 mm.  
∅ 12 mm.



**4-2015**  
L: 950 mm.  
∅ 12 mm.

**4-5005.1**  
L: 950 mm.  
∅ 14 mm.

**4-5008.1**  
L: 950 mm.  
∅ 14 mm.

**4-4013**  
L: 950 mm.  
∅ 14 mm.

**4-4015**  
L: 950 mm.  
∅ 14 mm.

**4-3005**  
L: 1.200 mm.  
∅ 16 mm.

**4-3008**  
L: 1.200 mm.  
∅ 16 mm.

**4-3013**  
L: 1.200 mm.  
∅ 16 mm.

**4-3015**  
L: 1.200 mm.  
∅ 16 mm.

# Barrotes decorativos

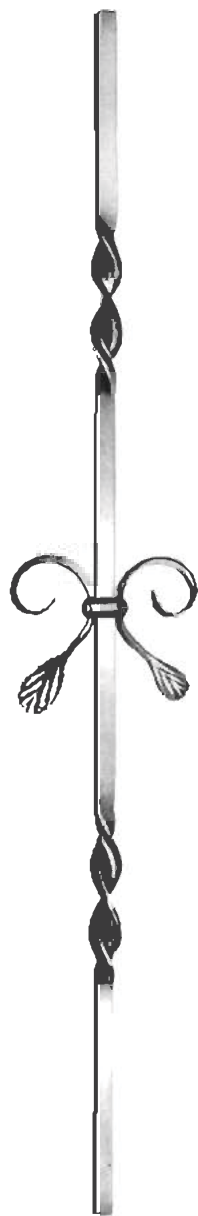

**4-2213**  
L: 950 mm.  
∅ 12 mm.

**4-4213**  
L: 950 mm.  
∅ 14 mm.

**4-3213**  
L: 1.200 mm.  
∅ 16 mm.



**4-2215**  
L: 950 mm.  
∅ 12 mm.

**4-4215**  
L: 950 mm.  
∅ 14 mm.

**4-3215**  
L: 1.200 mm.  
∅ 16 mm.



**4-2045**  
L: 950 mm.  
∅ 12 mm.

**4-4045**  
L: 950 mm.  
∅ 14 mm.

**4-3045**  
L: 1.200 mm.  
∅ 16 mm.



**4-2048**  
L: 950 mm.  
∅ 12 mm.

**4-4048**  
L: 950 mm.  
∅ 14 mm.

**4-3048**  
L: 1.200 mm.  
∅ 16 mm.

# Barrotes decorativos

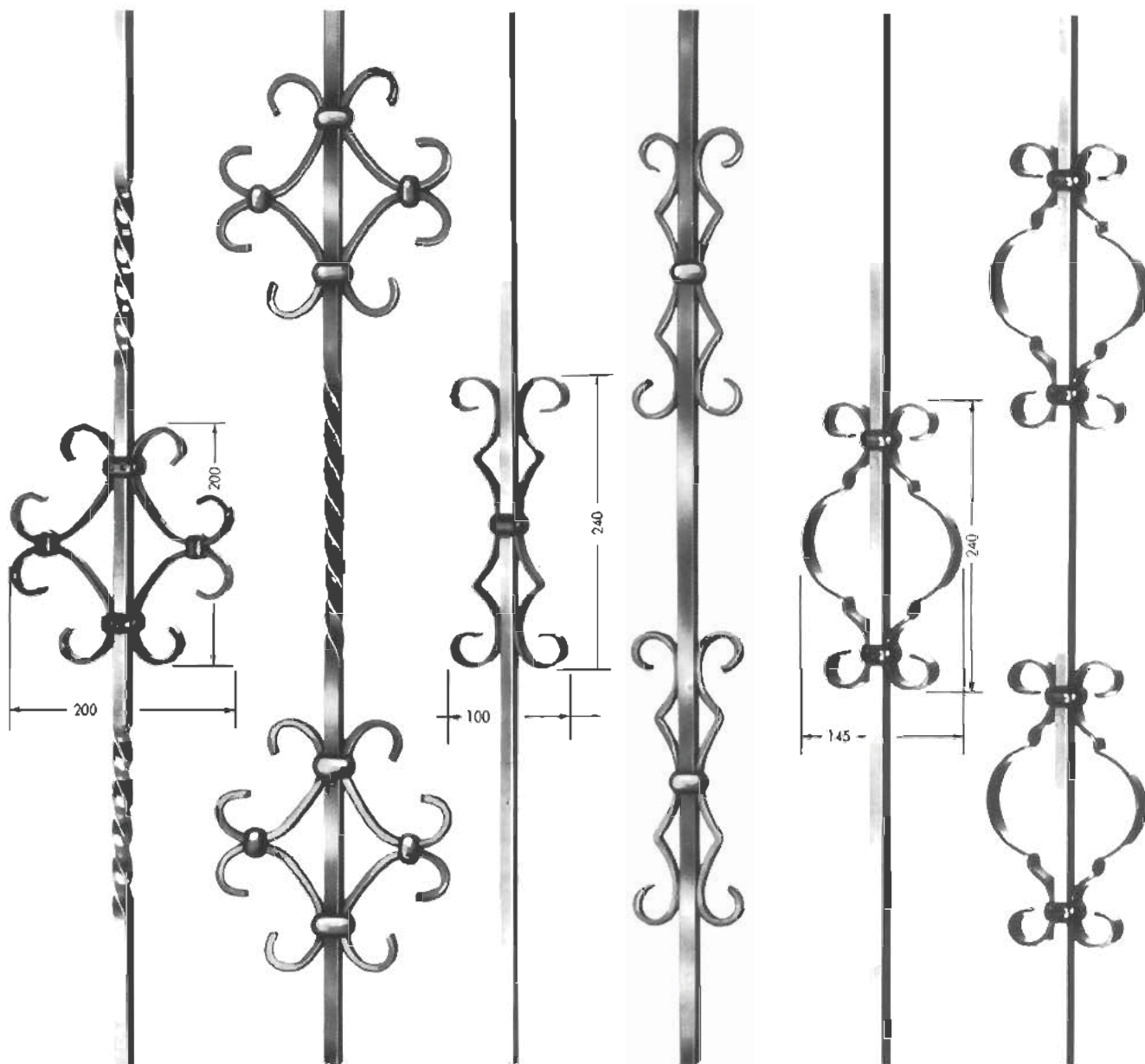

**4-2233**

L: 950 mm.  
Ø 12 mm.

**4-2234**

L: 950 mm.  
Ø 12 mm.

**4-2070**

L: 950 mm.  
Ø 12 mm.

**4-2071**

L: 950 mm.  
Ø 12 mm.

**4-2073**

L: 950 mm.  
Ø 12 mm.

**4-2074**

L: 950 mm.  
Ø 12 mm.

**4-3233**

L: 1.200 mm.  
Ø 16 mm.

**4-3234**

L: 1.200 mm.  
Ø 16 mm.

**4-3070**

L: 1.200 mm.  
Ø 16 mm.

**4-3071**

L: 1.200 mm.  
Ø 16 mm.

**4-3073**

L: 1.200 mm.  
Ø 16 mm.

**4-3074**

L: 1.200 mm.  
Ø 16 mm.

## Barrotes decorativos

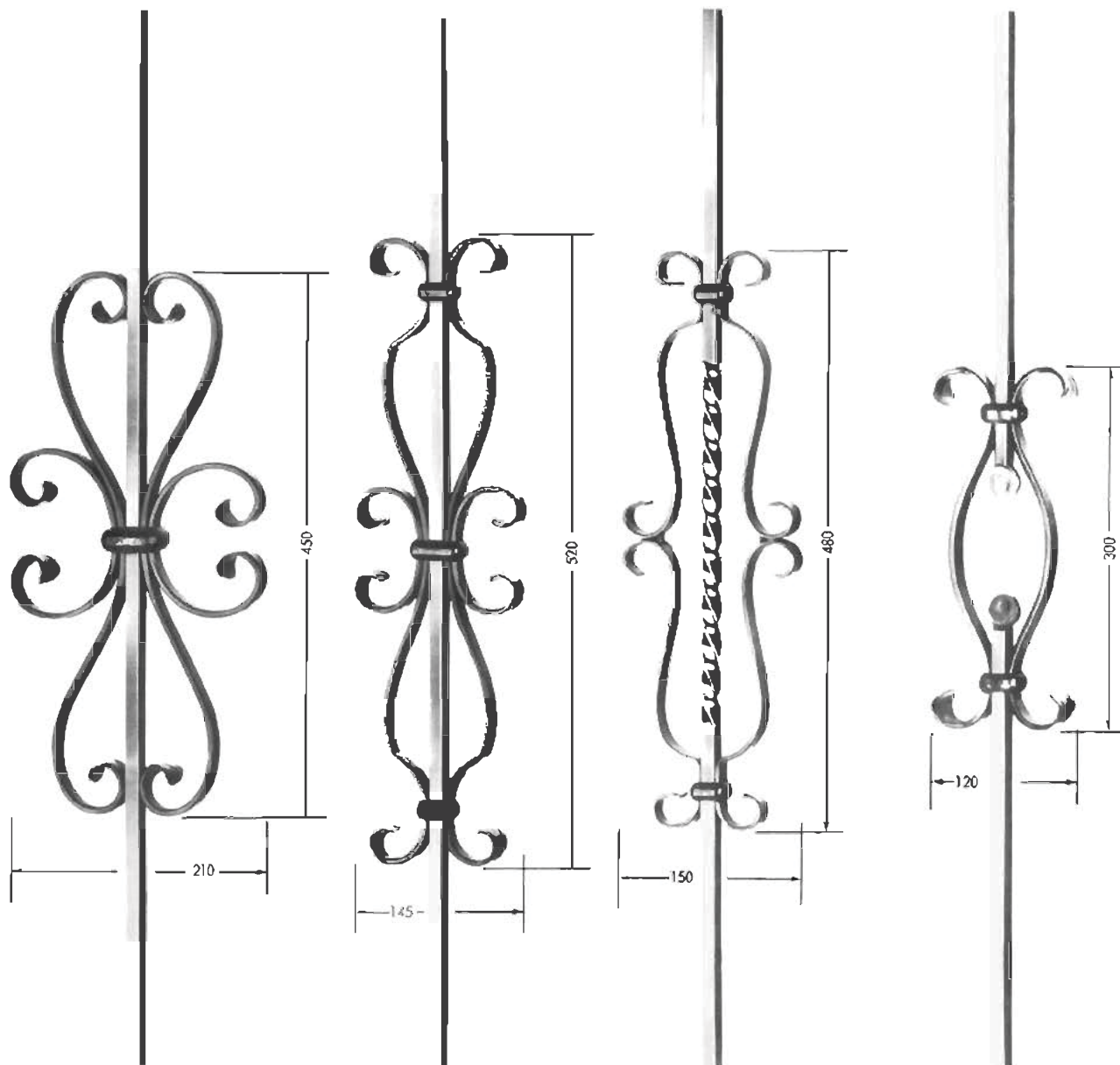

**4-2010**  
L: 950 mm.  
Ø 12 mm.

**4-4010**  
L: 950 mm.  
Ø 14 mm.

**4-3010**  
L: 1.200 mm.  
Ø 16 mm.

**4-2210**  
L: 950 mm.  
Ø 12 mm.

**4-4210**  
L: 950 mm.  
Ø 14 mm.

**4-3210**  
L: 1.200 mm.  
Ø 16 mm.

**4-2230**  
L: 950 mm.  
Ø 12 mm.

**4-3230**  
L: 1.200 mm.  
Ø 16 mm.

**4-2228**  
L: 950 mm.  
Ø 12 mm.

**4-3228**  
L: 1.200 mm.  
Ø 16 mm.

## Barrotes decorativos



4-2785  
L: 860 mm.  
pletina de 12 x 6.

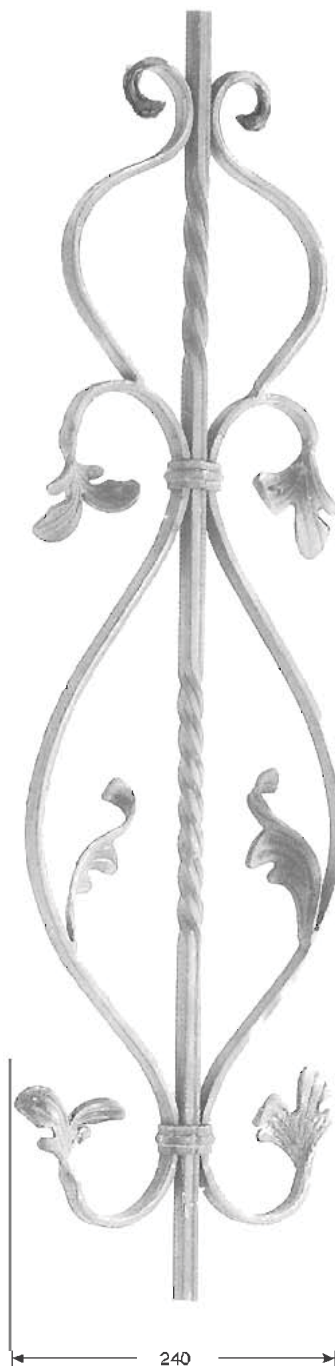

4-2786  
L: 950 mm.  
□ 12 mm.

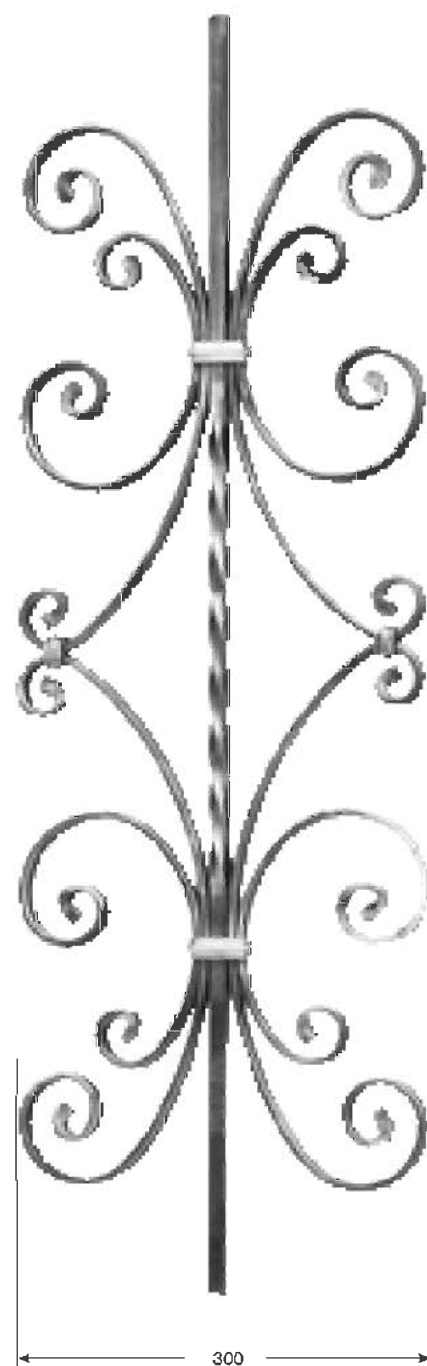

4-1084  
L: 950 mm.  
□ 12 mm.

# Barrotes decorativos

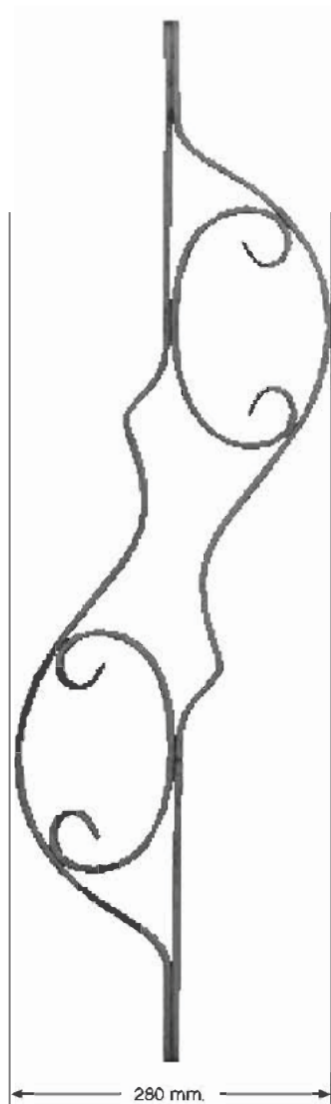

**4-5414**  
L: 950 mm.  
Ø 14 mm.  
(dos pletinas de 14x7).



**4-2965**  
L: 950 mm.  
Ø 12 mm.

**4-5965**  
L: 950 mm.  
Ø 14 mm.



**4-2966**  
L: 950 mm.  
Ø 12 mm.

**4-5966**  
L: 950 mm.  
Ø 14 mm.



**4-1025**  
L: 950 mm.  
Ø 12 mm.

**4-5025**  
L: 950 mm.  
Ø 14 mm.

**4-5625**  
L: 1.200 mm.  
Ø 16 mm.



**4-1026**  
L: 950 mm.  
Ø 12 mm.

**4-5026**  
L: 950 mm.  
Ø 14 mm.

**4-5626**  
L: 1.200 mm.  
Ø 16 mm.



## Barrotes decorativos

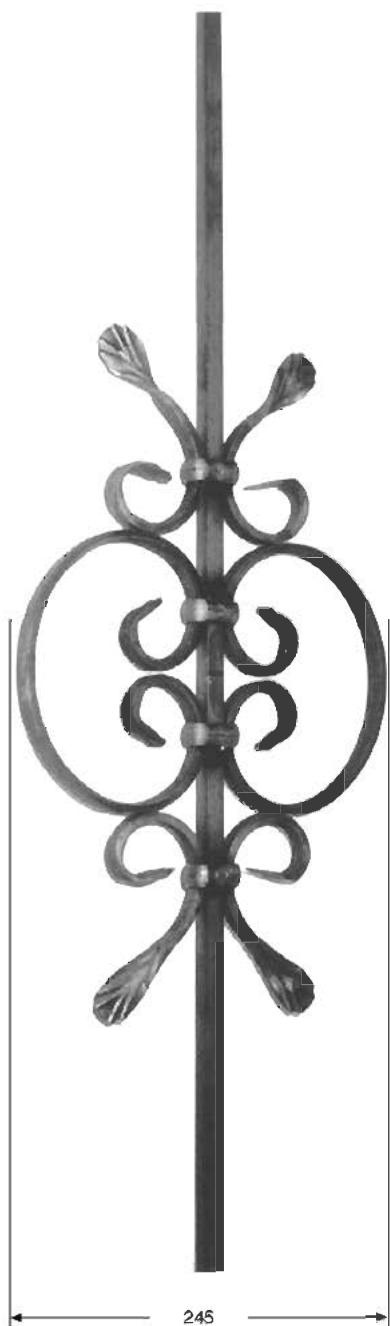

**4-2787**  
L: 950 mm.  
∅ 12 mm.

**4-3787**  
L: 1.200 mm.  
∅ 16 mm.

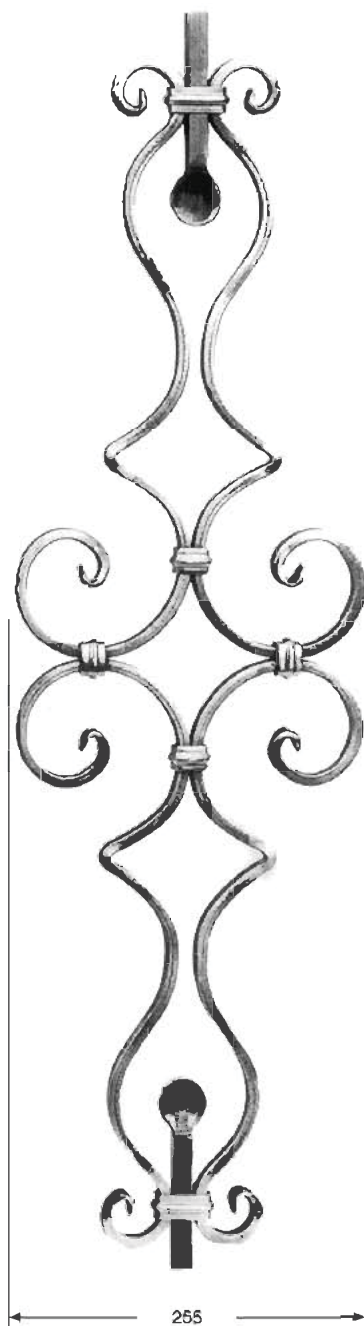

**4-2788**  
L: 250 x 900 mm.  
∅ 14 mm.



**4-1090**  
L: 950 mm.  
∅ 14 mm.



**4-1091**  
L: 950 mm.  
∅ 14 mm.

## Barrotes decorativos y forjados

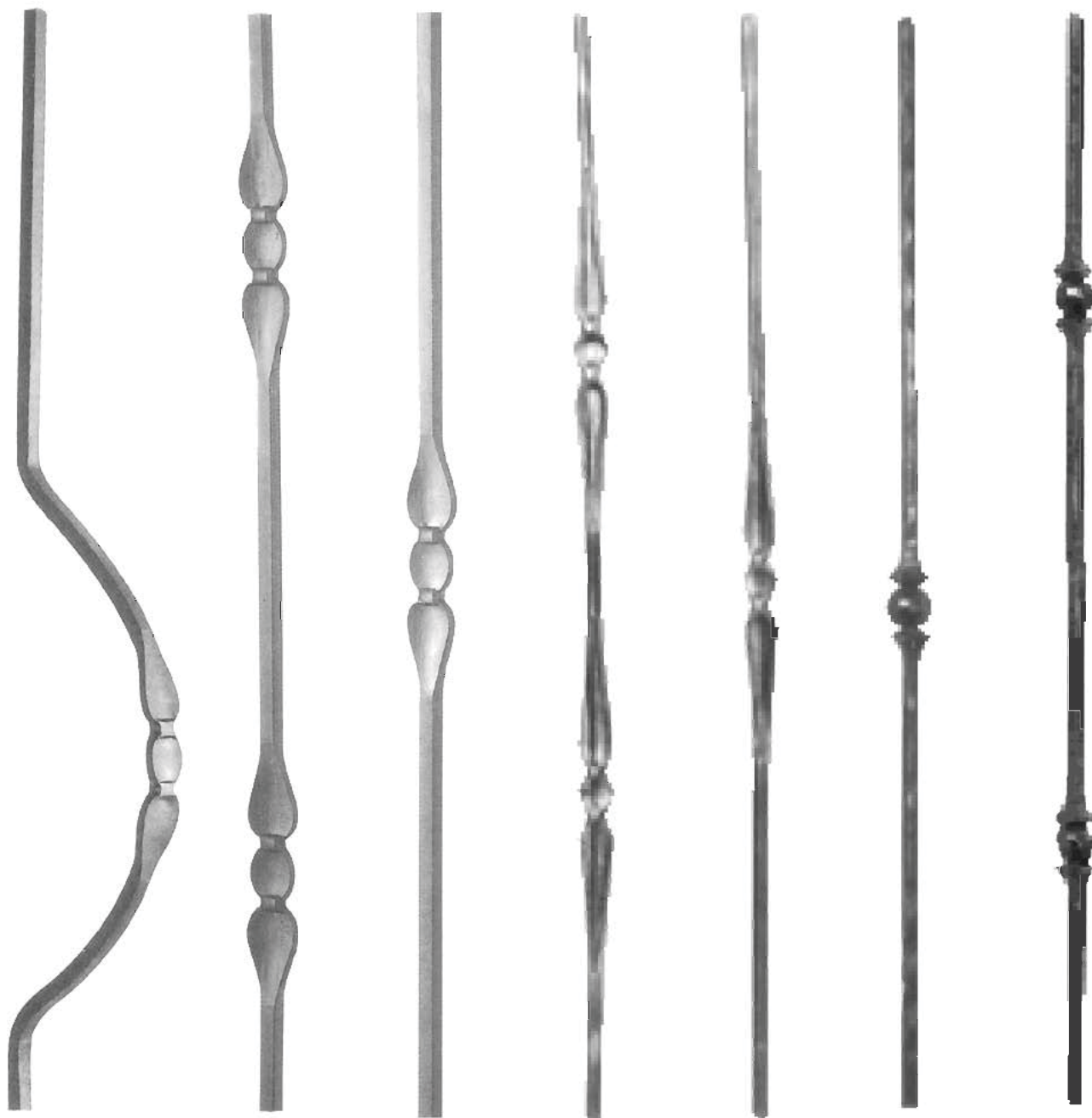

**4-5094**  
L: 950 mm.  
Ø 14 mm.

**4-5047**  
L: 950 mm.  
Ø 14 mm.

**4-5044**  
L: 950 mm.  
Ø 14 mm.

**4-1047**  
L: 950 mm.  
Ø 14 mm.

**4-1044**  
L: 950 mm.  
Ø 14 mm.

**4-1045**  
L: 950 mm.  
Ø 14 mm.

**4-1048**  
L: 950 mm.  
Ø 14 mm.

# Barrotes forjados



4-1055  
Ø 10 mm.  
L: 950 mm.



4-1060  
Ø 14 mm.  
L: 950 mm.



4-1065  
Ø 14 mm.  
L: 950 mm.



4-1068  
Ø 14 mm.  
L: 950 mm.



4-1070  
Ø 14 mm.  
L: 950 mm.



4-1071  
Ø 14 mm.  
L: 950 mm.

Adorno Ø 35 mm.

## Barrotes forjados



4-5040  
Ø 14 mm.  
L: 1000 mm.



4-5060  
Ø 13 mm.  
L: 1000 mm.

Adorno Ø 35 mm.

# Tubos ornamentales

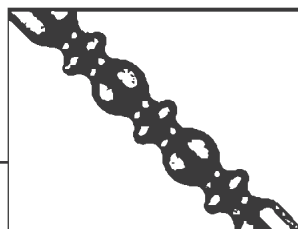

4-9260  
L: 950 mm.  
Ø 40 x 2 mm.



4-9262  
L: 950 mm.  
Ø 30 x 1,5 mm.



4-9264  
L: 950 mm.  
Ø 30 x 1,5 mm.

# Barrotes de relleno y decorativos con aristas trabajadas



**4-5045**  
L: 950 mm.  
Ø 14 mm.



**4-5048**  
L: 950 mm.  
Ø 14 mm.



**4-2202**  
L: 950 mm.  
Ø 12 mm.

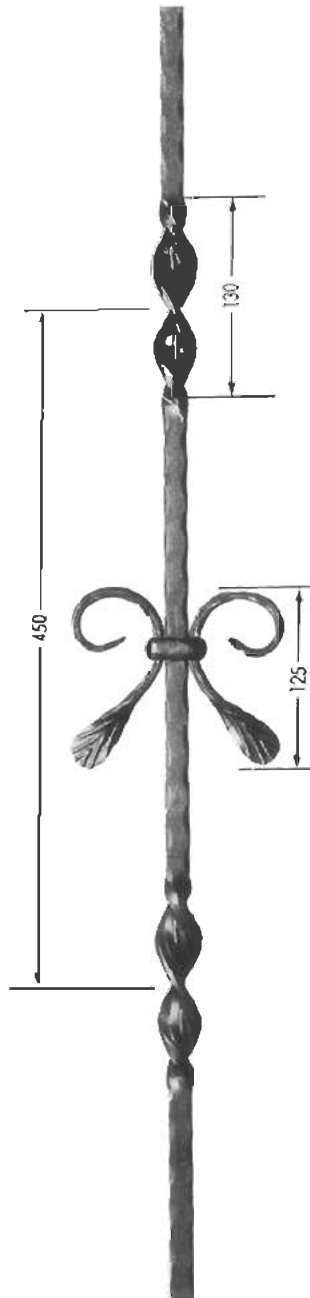

**4-5213**  
L: 950 mm.  
Ø 14 mm.

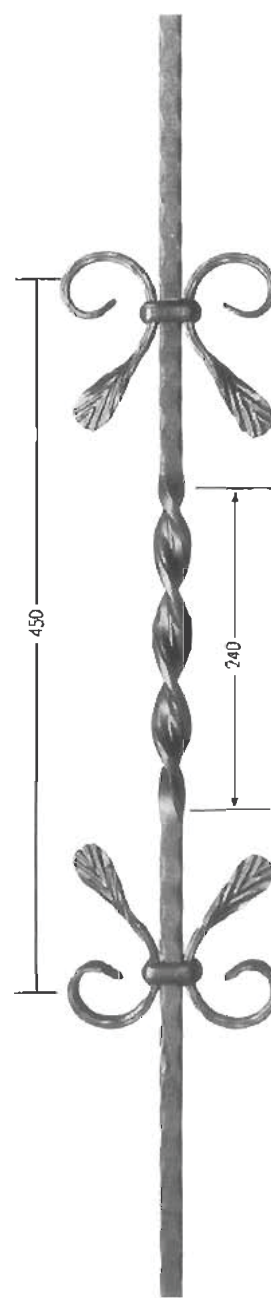

**4-5215**  
L: 950 mm.  
Ø 14 mm.

**4-5202**  
L: 950 mm.  
Ø 14 mm.

**4-3202**  
L: 1.200 mm.  
Ø 16 mm.

# Barrotes de relleno y decorativos

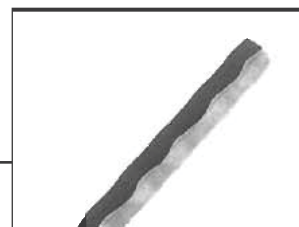

**4-5005**  
L: 950 mm.  
Ø 14 mm.



**4-5008**  
L: 950 mm.  
Ø 14 mm.

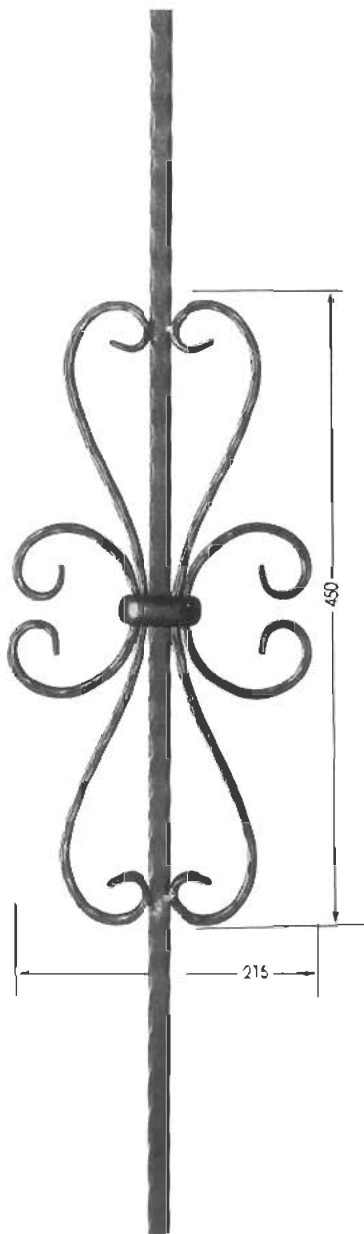

**4-5010**  
L: 950 mm.  
Ø 14 mm.

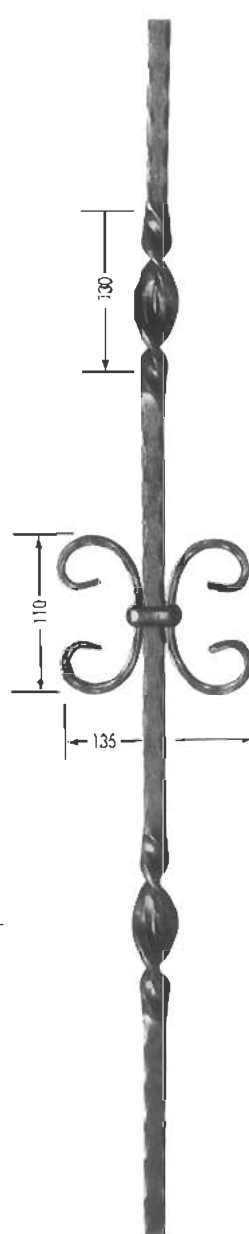

**4-5013**  
L: 950 mm.  
Ø 14 mm.

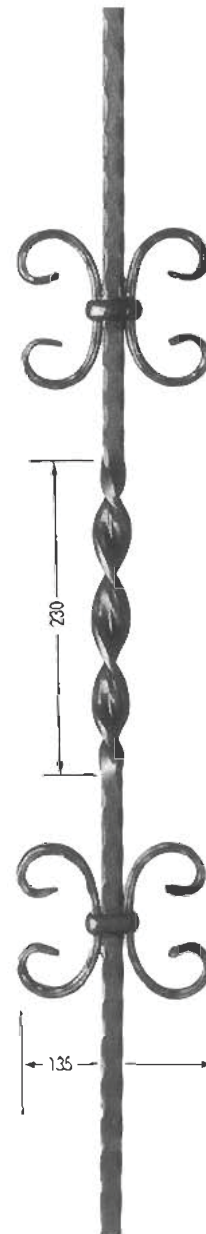

**4-5015**  
L: 950 mm.  
Ø 14 mm.

## Barrotes de relleno y decorativos



4-1000  
L: 1.200 mm.  
∅ 25 mm.



4-1001  
L: 950 mm.  
∅ 14 mm.



4-1002  
L: 950 mm.  
∅ 14 mm.



4-1004  
M: 110 x 950 mm.  
∅ 14 mm.

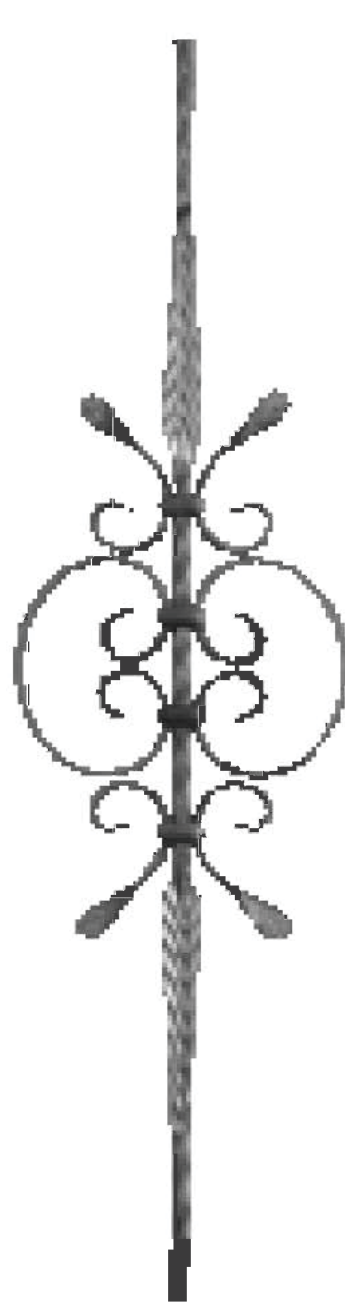

4-1006  
L: 950 mm.  
∅ 14 mm.



# Balconeras

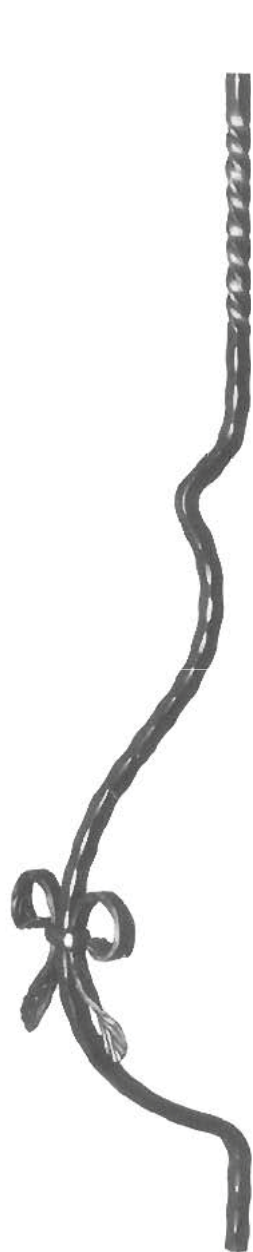

**4-5080**  
L: 950 mm.  
∅ 14 mm.



**4-5086**  
L: 950 mm.  
∅ 14 mm.



**4-5088**  
L: 950 mm.  
∅ 14 mm.



**4-5092**  
L: 950 mm.  
∅ 14 mm.

# Balconeras



**4-1099**  
M: 160 x 950 mm.  
Ø 12 mm.



**4-1094**  
L: 950 mm. Ø 12 mm.  
**4-1094.12**  
L: 950 mm. Ø 12 mm. Liso  
**4-1094.14**  
L: 950 mm. Ø 14 mm. Liso



**4-5082**  
L: 950 mm.  
Ø 14 mm.



**4-5084**  
L: 950 mm.  
Ø 14 mm.



**4-5090**  
L: 950 mm.  
Ø 14 mm.

# Balconeras

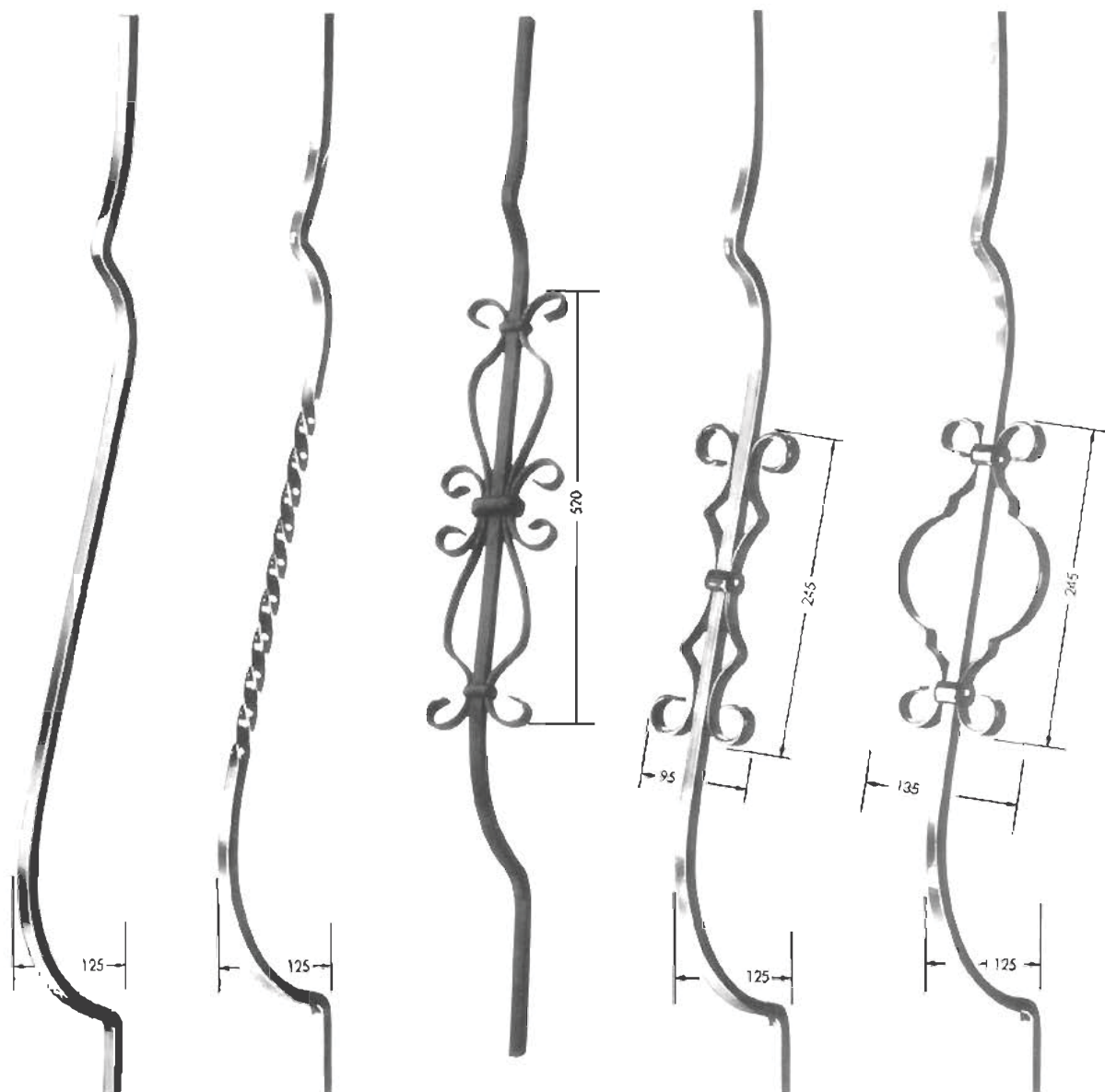

**4-2094**  
L: 950 mm.  
Ø 12 mm.

**4-2095**  
L: 950 mm.  
Ø 12 mm.

**4-3096**  
L: 1.200 mm.  
Ø 16 mm.

**4-2098**  
L: 950 mm.  
Ø 12 mm.

**4-2099**  
L: 950 mm.  
Ø 12 mm.

**4-4094**  
L: 950 mm.  
Ø 14 mm.

**4-4095**  
L: 950 mm.  
Ø 14 mm.

**4-4098**  
L: 950 mm.  
Ø 14 mm.

**4-4099**  
L: 950 mm.  
Ø 14 mm.

**4-3094**  
L: 1.200 mm.  
Ø 16 mm.

**4-3095**  
L: 1.200 mm.  
Ø 16 mm.

**4-3098**  
L: 1.200 mm.  
Ø 16 mm.

**4-3099**  
L: 1.200 mm.  
Ø 16 mm.

# Elementos decorativos



**4-1080**  
Medidas: 250 x 250 mm.  
Material: 12 x 6 mm.

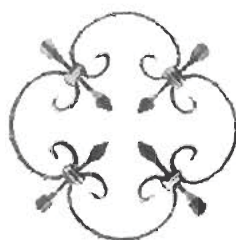

**4-1082**  
Medidas: 250 x 250 mm.  
Material: 10 x 5 mm.

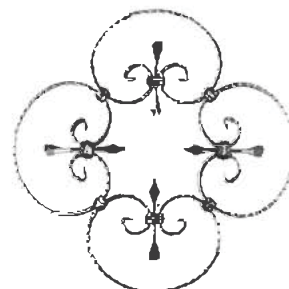

**4-1088**  
Medidas: 380 x 380 mm.  
Material: 10 x 5 mm.

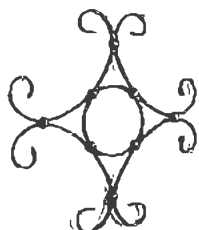

**4-2780**  
Medidas: 425 x 425 mm.  
Material: 12 x 6 mm.

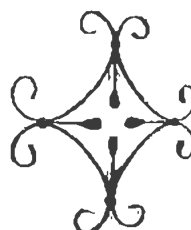

**4-2782**  
Medidas: 425 x 425 mm.  
Material: 12 x 6 mm.



**4-2680**  
Medidas: 250 x 250 mm.  
Material: 12 x 6 mm.



**4-2682**  
Medidas: 250 x 250 mm.  
Material: 12 x 6 mm.



**4-1062**  
M: 235 x 720 mm.  
∅ 20 x 6 mm.



**4-1079**  
M: 280 x 810 mm.  
∅ 30 x 8 mm.

# Cabezales decorativos

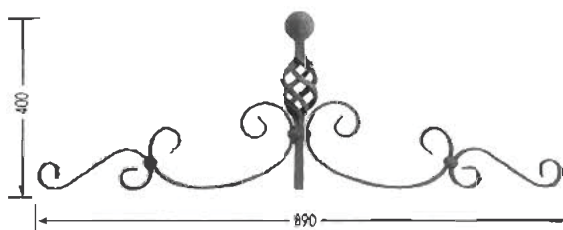
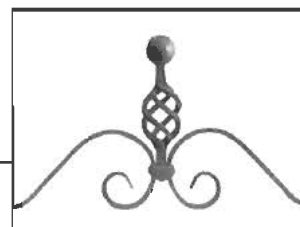

**4-2302**  
Medidas: 890 x 400 mm.  
M: 12 x 6 mm.

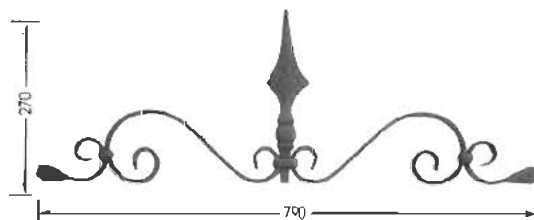

**4-2304**  
Medidas: 790 x 270 mm.  
M: 12 x 6 mm.

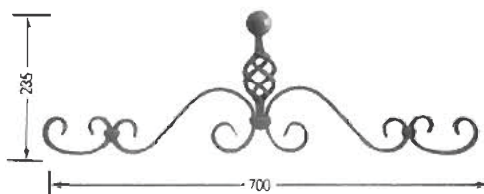

**4-2306**  
Medidas: 700 x 235 mm.  
M: 12 x 6 mm.

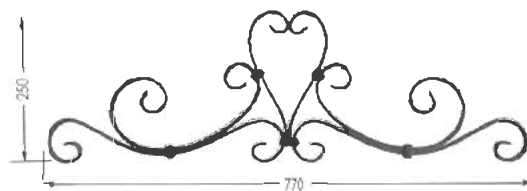

**4-2308**  
Medidas: 770 x 250 mm.  
M: 12 x 6 mm.



**4-2309**  
Medidas: 475 x 235 mm.  
M: 12 x 6 mm.

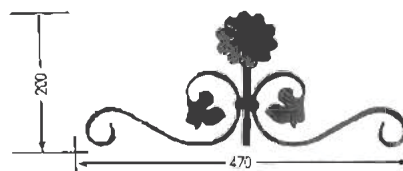

**4-2312**  
Medidas: 470 x 200 mm.  
M: 12 x 6 mm.



**4-2314**  
Medidas: 530 x 120 mm.  
M: 12 x 6 mm.



**4-2313**  
Medidas: 1.170 x 200 mm.  
M: 12 x 6 mm.

# Elementos decorativos

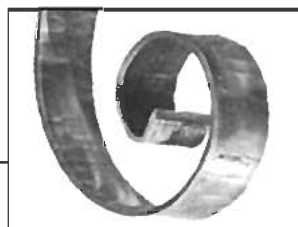

**4-12143**  
M: 360 x 120 mm.  
∅ 12 x 6 mm.



**4-12142**  
M: 360 x 120 mm.  
∅ 12 x 6 mm.



**4-12144**  
M: 290 x 120 mm.  
∅ 12 x 6 mm.



**4-12146**  
M: 220 x 120 mm.  
∅ 12 x 6 mm.

**4-13143**  
M: 360 x 120 mm.  
∅ 16 x 4 mm.

**4-13142**  
M: 360 x 120 mm.  
∅ 16 x 4 mm.

**4-13144**  
M: 290 x 120 mm.  
∅ 16 x 4 mm.

**4-13146**  
M: 220 x 120 mm.  
∅ 16 x 4 mm.



**4-1042**  
M: ∅ 12 x 6 mm.  
Medidas: 120 x 350 mm.

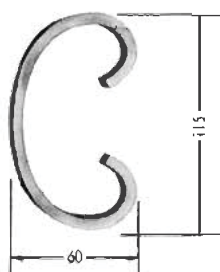

**4-2135**  
M: ∅ 12 x 6 mm.

**4-3135**  
M: ∅ 16 x 6 mm.



**4-11035**  
M: ∅ 12 x 6 mm.  
Medidas: 180 x 90 mm.

**4-13035**  
M: ∅ 16 x 4 mm.  
Medidas: 180 x 90 mm.



**4-12141**  
M: ∅ 12 x 6 mm.  
Medidas: 115 x 60 mm.

**4-13141**  
M: ∅ 16 x 4 mm.  
Medidas: 115 x 60 mm.



**4-1035**  
M: ∅ 12 x 6 mm.  
Medidas: 75 x 150 mm.

**4-1041**  
M: ∅ 12 x 6 mm.  
Medidas: 75 x 130 mm.

# Elementos decorativos

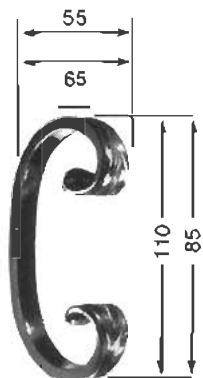

**4-2141**  
M: 12 x 6 mm.  
Medidas: 110 x 60 mm.

**4-2141.C**  
M: 12 x 6 mm.  
Medidas: 85 x 55 mm.

**4-5141**  
M: 14 x 6 mm.  
Medidas: 110 x 65 mm.

**4-5141.C**  
M: 14 x 6 mm.  
Medidas: 85 x 55 mm.

**4-3141**  
M: 16 x 6 mm.  
Medidas: 110 x 60 mm.

**4-3141.C**  
M: 16 x 6 mm.  
Medidas: 85 x 55 mm.

**4-2133**  
M: 12 x 6 mm.  
Medidas: 120 x 65 mm.

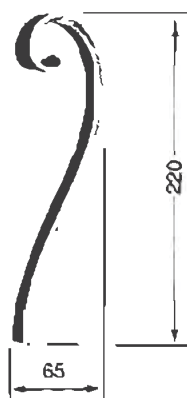

**4-2144**  
M: 12 x 6 mm.

**4-3144**  
M: 16 x 6 mm.

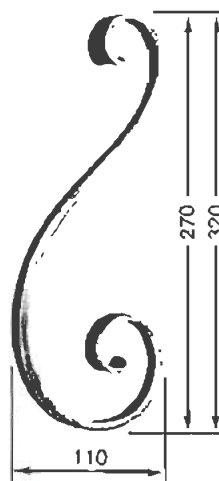

**4-2142**  
M: 12 x 6 mm.  
Medidas: 270 x 110 mm.

**4-2145**  
M: 12 x 6 mm.  
Medidas: 190 x 70 mm.

**4-2146**  
M: 12 x 6 mm.  
Medidas: 230 x 110 mm.

**4-2147**  
M: 12 x 6 mm.  
Medidas: 320 x 110 mm.

**4-3142**  
M: 16 x 6 mm.  
Medidas: 270 x 110 mm.

**4-3145**  
M: 16 x 6 mm.  
Medidas: 190 x 70 mm.

**4-3146**  
M: 16 x 6 mm.  
Medidas: 230 x 110 mm.

**4-3147**  
M: 16 x 6 mm.  
Medidas: 320 x 110 mm.

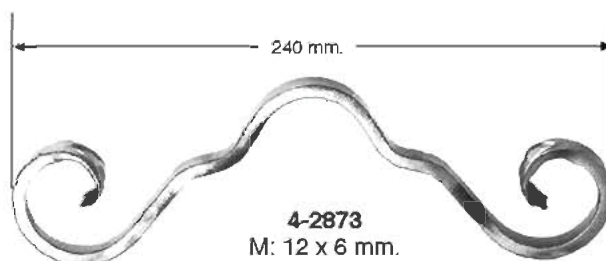

**4-2873**  
M: 12 x 6 mm.



**4-2143**  
M: 12 x 6 mm.  
Medidas: 320 x 110 mm.

**4-3143**  
M: 16 x 6 mm.  
Medidas: 320 x 110 mm.



**4-2139**  
M: 16 x 4 mm.  
Medidas: 290 x 120 mm.

## Elementos decorativos

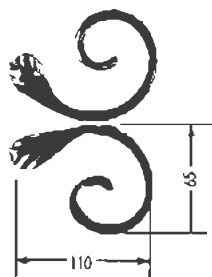
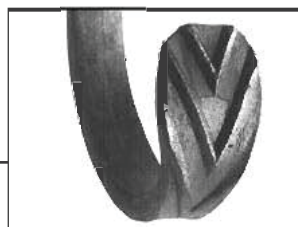

**4-2130**  
M:  $\varnothing$  12 x 6 mm.  
Derecha

**4-2131**  
M:  $\varnothing$  12 x 6 mm.  
Izquierda

**4-3130**  
M:  $\varnothing$  16 x 6 mm.  
Derecha

**4-3131**  
M:  $\varnothing$  16 x 6 mm.  
Izquierda

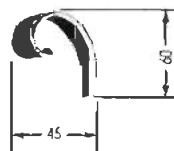

**4-2132**  
M:  $\varnothing$  12 x 6 mm.

**4-3132**  
M:  $\varnothing$  16 x 6 mm.

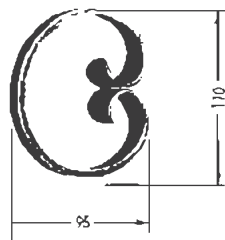

**4-2136**  
M:  $\varnothing$  12 x 6 mm.

**4-3136**  
M:  $\varnothing$  16 x 6 mm.

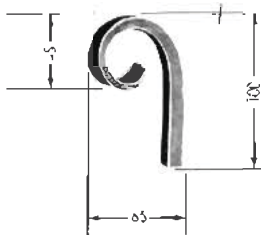

**4-2134**  
M:  $\varnothing$  12 x 12 mm.

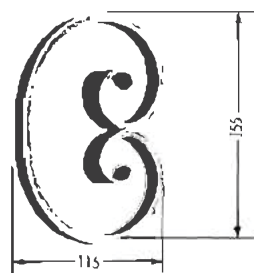

**4-2140**  
M:  $\varnothing$  12 x 6 mm.

**4-3140**  
M:  $\varnothing$  16 x 6 mm.

## Material con canto trabajado

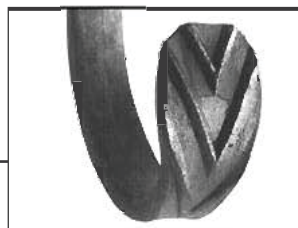

Medidas: 320 x 110 mm.

**4-2720**  
M:  $\varnothing$  12 x 6 mm. Derecha

**4-2721**  
M:  $\varnothing$  12 x 6 mm. Izquierda

**4-2722**  
M:  $\varnothing$  14 x 6 mm. Derecha

**4-2723**  
M:  $\varnothing$  14 x 6 mm. Izquierda

**4-2724**  
M:  $\varnothing$  16 x 6 mm. Derecha

**4-2725**  
M:  $\varnothing$  16 x 6 mm. Izquierda

Medidas: 230 x 110 mm.

**4-2700**  
M:  $\varnothing$  12 x 6 mm. Derecha

**4-2701**  
M:  $\varnothing$  12 x 6 mm. Izquierda

**4-2702**  
M:  $\varnothing$  14 x 6 mm. Derecha

**4-2703**  
M:  $\varnothing$  14 x 6 mm. Izquierda

**4-2704**  
M:  $\varnothing$  16 x 6 mm. Derecha

**4-2705**  
M:  $\varnothing$  16 x 6 mm. Izquierda



# Material con canto trabajado



Medidas: 95 x 140 mm.

4-2750 M:  $\varnothing$  12 x 6 mm. Derecha  
4-2751 M:  $\varnothing$  12 x 6 mm. Izquierda

4-2752 M:  $\varnothing$  14 x 6 mm. Derecha  
4-2753 M:  $\varnothing$  14 x 6 mm. Izquierda

4-2754 M:  $\varnothing$  16 x 6 mm. Derecha  
4-2755 M:  $\varnothing$  16 x 6 mm. Izquierda



Medidas: 125 x 235 mm.

4-2760 M:  $\varnothing$  12 x 6 mm. Derecha  
4-2761 M:  $\varnothing$  12 x 6 mm. Izquierda

4-2762 M:  $\varnothing$  14 x 6 mm. Derecha  
4-2763 M:  $\varnothing$  14 x 6 mm. Izquierda

4-2764 M:  $\varnothing$  16 x 6 mm. Derecha  
4-2765 M:  $\varnothing$  16 x 6 mm. Izquierda

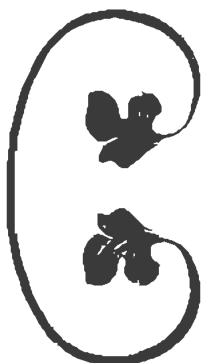

Medidas: 135 x 235 mm.

4-2770 M:  $\varnothing$  12 x 6 mm.

4-2772 M:  $\varnothing$  14 x 6 mm.

4-2774 M:  $\varnothing$  16 x 6 mm.

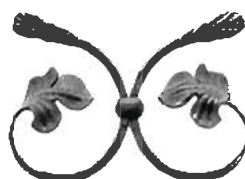

Medidas: 190 x 140 mm.

4-2776 M:  $\varnothing$  12 x 6 mm.



Medidas aprox.: 55x 85 mm.

4-2100  
M:  $\varnothing$  12 x 6 mm.

4-2110  
M:  $\varnothing$  14 x 6 mm.

4-2120  
M:  $\varnothing$  16 x 6 mm.



Medidas aprox.: 60 x 110 mm.

4-2102  
M:  $\varnothing$  12 x 6 mm.

4-2112  
M:  $\varnothing$  14 x 6 mm.

4-2122  
M:  $\varnothing$  16 x 6 mm.



Medidas aprox.: ancho superior: 54 mm.,  
ancho inferior: 70 mm., alto: 190 mm.

4-2104  
M:  $\varnothing$  12 x 6 mm.

4-2114  
M:  $\varnothing$  14 x 6 mm.

4-2124  
M:  $\varnothing$  16 x 6 mm.



Medidas aprox.: ancho superior: 94 mm.,  
ancho inferior: 110 mm., alto: 320 mm.

4-2106  
M:  $\varnothing$  12 x 6 mm.

4-2116  
M:  $\varnothing$  14 x 6 mm.

4-2126  
M:  $\varnothing$  16 x 6 mm.

# Hojas de Forja estampadas y flores

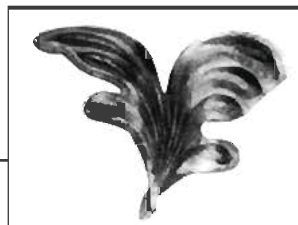

Medidas: 100 x 86 mm.

**4-7488**

Hoja estampada «ART»  
Derecha

**4-7487**

Hoja estampada «ART»  
Izquierda



Medidas: 75 x 59 mm.

**4-7486**

Hoja estampada «ART»  
Derecha

**4-7485**

Hoja estampada «ART»  
Izquierda



**4-1075**

∅ 3 mm.

Medidas: 70 x 60 mm.  
derecha

**4-1076**

∅ 3 mm.

Medidas: 70 x 60 mm.  
izquierda



**4-7491**

∅ 5 mm.

Medidas: 160 x 80 mm.



**4-7492**

∅ 5 mm.

Medidas: 170 x 95 mm.



**4-2189**

∅ 65 mm.

∅ 3 mm.

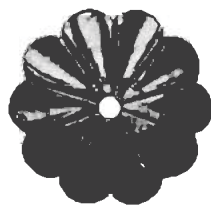

**4-2181**

∅ 92 mm.

∅ 3 mm.

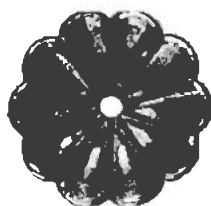

**4-2182**

∅ 77 mm.

∅ 3 mm.



**4-1081**

∅ 90 mm.

∅ 2 mm.

## Hojas de Forja estampadas y flores



**4-1083**  
 ∅ 55 mm. ▨ 0,3 mm.

**4-1083.9**  
 ∅ 90 mm. ▨ 0,3 mm.



**4-1085**  
 95 x 105 mm.  
 ▨ 0,5 mm.



**4-1086**  
 65 x 130 mm.  
 ▨ 0,5 mm.



**4-1093**  
 200 x 64 mm.  
 ▨ 0,5 mm.



**4-1089**  
 70 x 28 mm.  
 ▨ 0,5 mm.



**4-1095**  
 28 x 60 mm.  
 ▨ 0,5 mm.



**4-1096**  
 35 x 70 mm.  
 ▨ 0,5 mm.



**4-1097**  
 45 x 85 mm.  
 ▨ 0,5 mm.

## Bolas de hierro

### “ LISAS ”



- ∅ 20 mm. 4-7520
- ∅ 25 mm. 4-7525
- ∅ 30 mm. 4-7530
- ∅ 35 mm. 4-7535
- ∅ 40 mm. 4-7540
- ∅ 50 mm. 4-7550
- ∅ 60 mm. 4-7560
- ∅ 70 mm. 4-7570
- ∅ 80 mm. 4-7580
- ∅ 90 mm. 4-7590
- ∅ 100 mm. 4-7600

### “ FORJADAS ”



- ∅ 20 mm. 4-7520.1
- ∅ 30 mm. 4-7530.1
- ∅ 40 mm. 4-7540.1
- ∅ 50 mm. 4-7550.1

# Lanzas de Hierro (soldables)



4-2390  
 Ø 13 mm. L: 130 mm.  
 4-2391  
 Ø 16 mm. L: 160 mm.  
 4-2392  
 Ø 18 mm. L: 195 mm.



4-2397  
 Ø 12 mm. L: 130 mm.  
 4-2398  
 Ø 16 mm. L: 155 mm.  
 4-2399  
 Ø 20 mm. L: 190 mm.



4-2395  
 Ø 16 mm. L: 165 mm.



4-2396  
 Ø 16 mm. L: 265 mm.



4-2393  
 Ø 16 mm. L: 160 mm.



4-2394  
 Ø 15 mm. L: 155 mm.



4-2400  
 Ø 14 mm. L: 180 mm.



4-2351  
 Ø 16 mm. L: 155 mm.



4-2352  
 Ø 25 mm. L: 125 mm.



4-2353  
 Ø 10 mm. L: 140 mm.



4-2354  
 Ø 14 mm. L: 140 mm.



4-2357  
 Ø 35 mm. L: 125 mm.



4-2355  
 Ø 40 mm. L: 255 mm.



4-2356  
 Ø 16 mm. L: 175 mm.



4-2410  
 Ø 12 mm. L: 150 mm.  
 4-2411  
 Ø 14 mm. L: 150 mm.  
 4-2412  
 Ø 16 mm. L: 200 mm.  
 4-2413  
 Ø 20 mm. L: 215 mm.

# Elementos decorativos

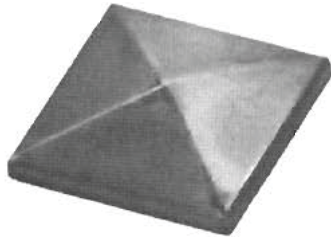

4-0230  $\varnothing$  30 mm.

4-0240  $\varnothing$  40 mm.

4-0250  $\varnothing$  50 mm.

4-0260  $\varnothing$  60 mm.

4-0280  $\varnothing$  80 mm.

4-02100  $\varnothing$  100 mm.

4-02120  $\varnothing$  120 mm.

4-02150  $\varnothing$  150 mm.

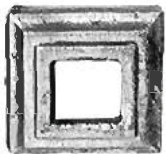

4-2163  
Terminal para barrotes  
 $\varnothing$  40 mm.  
80X80 mm.

4-2168  
Terminal para barrotes  
 $\varnothing$  30 mm.  
62X62 mm.



4-2164  
Terminal para barrotes  $\varnothing$  14 mm.

4-2165  
Terminal para barrotes  $\varnothing$  12 mm.

4-2166  
Terminal para barrotes  $\varnothing$  16 mm.

4-2167  
Terminal para barrotes  $\varnothing$  20 mm.

# Tapa cerradura, manubrios y bisagras forjadas

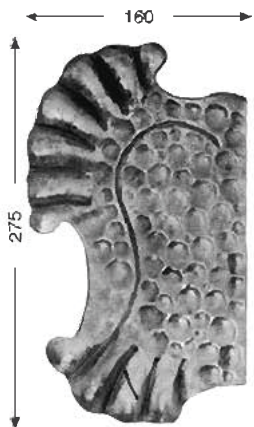

4-8961  
M: 275 x 160 mm.  
Izquierda

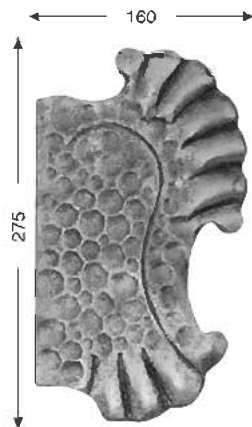

4-8960  
M: 275 x 160 mm.  
Derecha

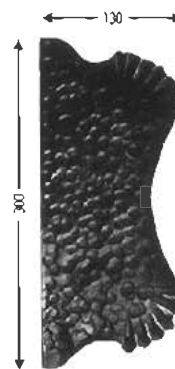

4-8265  
M: 300 x 130 mm.

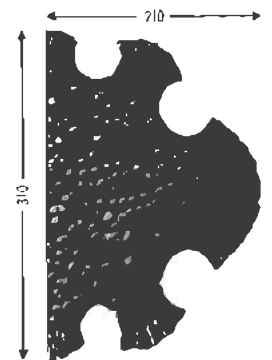

4-8267  
M: 310 x 210 mm.

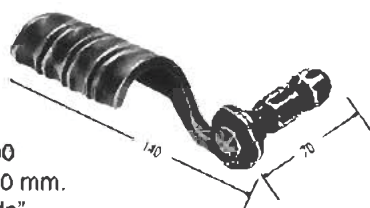

4-7400  
M: 140 x 70 mm.  
"Forjado"

DERECHA E IZQUIERDA "JUEGO COMPLETO"



4-7305  
M: 100 x 20 mm.



4-7310  
M: 125 x 25 mm.



4-7315  
M: 150 x 30 mm.

# Material trabajado



4-2150 Para  $\varnothing$  12 mm. L: 130 mm.

4-5810 Para  $\varnothing$  14 mm. L: 130 mm.

4-2152 Para  $\varnothing$  16 mm. L: 165 mm.

4-2151 Para  $\varnothing$  20 mm. L: 205 mm.

4-2153 Para  $\varnothing$  25 mm. L: 220 mm.

4-5812 Para  $\varnothing$  30 mm. L: 250 mm.



4-1250

$\varnothing$  43 mm. L: 85 mm.

4-1251

$\varnothing$  55 mm. L: 120 mm.



4-1252

$\varnothing$  70 mm. L: 95 mm.

Base  $\varnothing$  46. M10



4-1253

$\varnothing$  75 mm. L: 160 mm.

Base  $\varnothing$  44

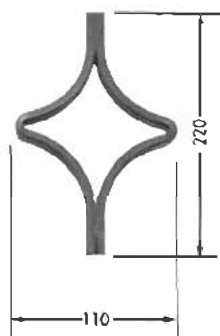

4-2170  
Formada por  
dos pletinas de 12 x 6

4-4170  
Formada por  
dos pletinas de 14 x 7

## Macollas

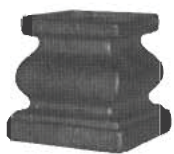

**4-1010**  
Brida 14 x 14 mm.  
M: 35 x 35 mm.



**4-5714**  
Brida Pas.  
14 x 14 mm.



**4-5715**  
Brida Doble Pas.  
14 x 14 mm.

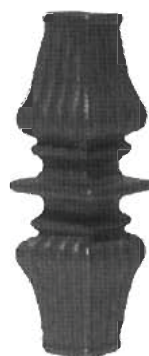

**4-1018**  
Brida 16 x 16 mm.  
M: 72 x 40 mm.

**4-1011**  
Brida 16 x 16 mm.  
M: 35 x 35 mm.

**4-5716**  
Brida Pas.  
16 x 16 mm.

**4-5721**  
Brida Doble Pas.  
16 x 16 mm.

**4-1012**  
Brida 20 x 20 mm.  
M: 35 x 35 mm.

**4-5720**  
Brida Pas.  
20 x 20 mm.

**4-5725**  
Brida Doble Pas.  
20 x 20 mm.

**4-1020**  
Brida 16 x 16 mm.  
M: 142 x 45 mm.



**4-1016**  
Brida  $\varnothing$  16 mm.  
M: 19 x 36 mm.



**4-1046**  
Brida  $\varnothing$  16 mm.  
M: 72 x 39 mm.



**4-1049**  
Brida  $\varnothing$  16 mm.  
M: 127 x 39 mm.



**4-1049D**  
Brida  $\varnothing$  16 mm.  
M: 185 x 40 mm.



**4-1050**  
Brida Doble Pas.  $\varnothing$  16 mm.  
M: 45 x 68 mm.



**4-1051**  
Brida Pas.  $\varnothing$  16 mm.  
M: 45 x 44 mm.

**4-1014**  
Brida  $\varnothing$  14 mm.

## Cuarterones

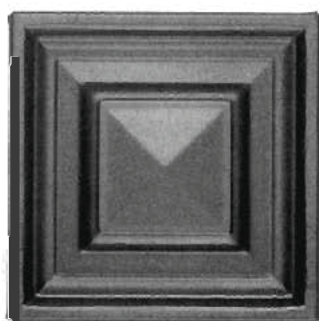

**4-1750** M: 200x200 mm. "Punta Diamante"

**4-1751** M: 400x200 mm. "Punta Diamante"

**4-1752** M: 200x200 mm. "Normal"

**4-1753** M: 400x200 mm. "Normal"

# Elementos de fundición

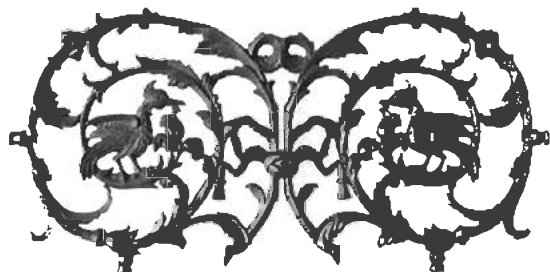
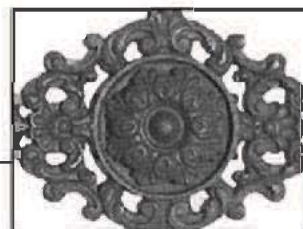

4-1030  
M: 1010 x 500 mm.

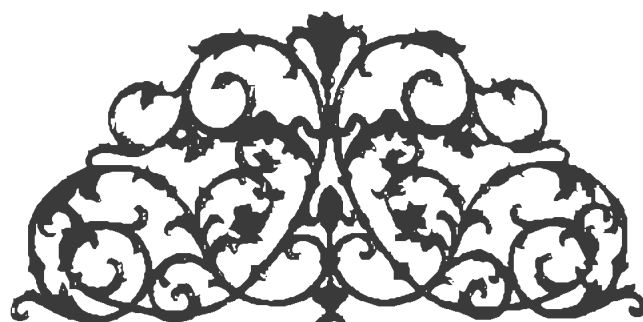

4-1040  
M: 1400 x 680 mm.

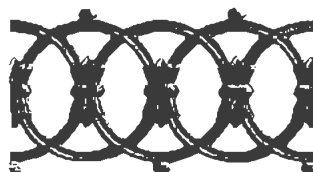

4-1033  
M: 910 x 155 mm.



4-1033  
M: 892 x 155 mm.



4-1073  
M: 80 x 80 mm.



4-1077  
M: 395 x 235 mm.  
4-1078  
M: 230 x 130 mm.



4-1074  
M: 160 x 160 mm.



# Adornos



4-F0100  
Adorno  $\varnothing$  16 mm.  
M: 220 x 155 mm.



4-F0101  
Adorno  $\square$  16 mm.  
M: 220 x 155 mm.



4-F0102  
Adorno  $\varnothing$  16 mm.  
M: 185 x 135 mm.  $\square$  16 mm.



4-F0200  
Adorno  $\varnothing$  16 mm.  
M: 220 x 315 mm.

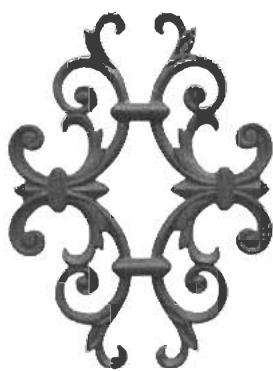

4-F0201  
Adorno  $\square$  16 mm.  
M: 220 x 315 mm.

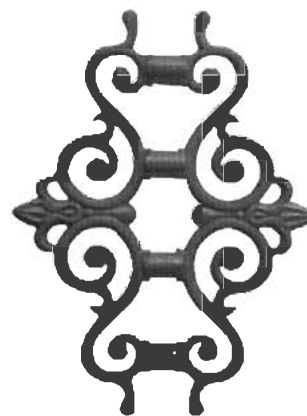

4-F0202  
Adorno  $\square$  16 mm.  
M: 205 x 270 mm.



4-F0225  
Adorno  $\square$  16 mm.  
M: 205 x 400 mm.



4-F0230  
Adorno  $\square$  16 mm.  
M: 170 x 300 mm.

# Bridas

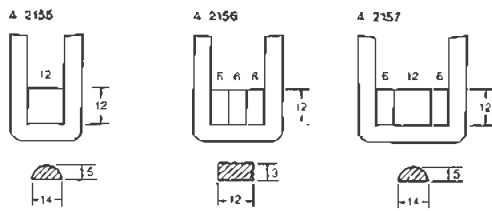

- 4-2155 Abrazadera para  $\varnothing$  12 mm.
- 4-2156 Abrazadera para  $\varnothing$  12 mm.
- 4-2157 Abrazadera para  $\varnothing$  12 mm.

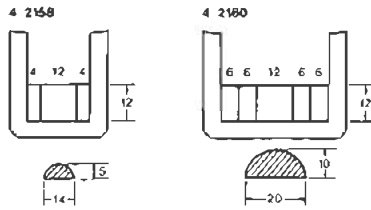

- 4-2158 Abrazadera para  $\varnothing$  12 mm.
- 4-2160 Abrazadera para  $\varnothing$  12 mm.

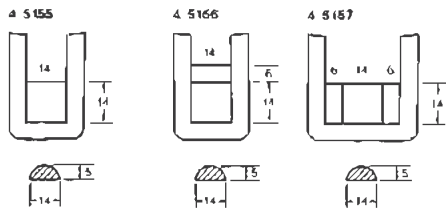

- 4-5155 Abrazadera para  $\varnothing$  14 mm.
- 4-5156 Abrazadera para  $\varnothing$  14 mm.
- 4-5157 Abrazadera para  $\varnothing$  14 mm.

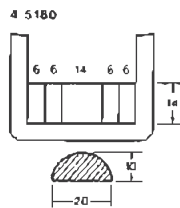

- 4-5160 Abrazadera para  $\varnothing$  14 mm.

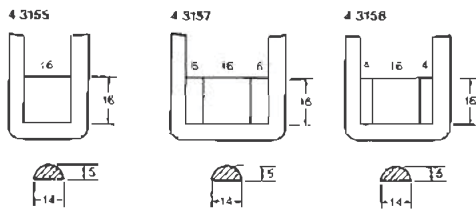

- 4-3155 Abrazadera para  $\varnothing$  16 mm.
- 4-3157 Abrazadera para  $\varnothing$  16 mm.
- 4-3158 Abrazadera para  $\varnothing$  16 mm.

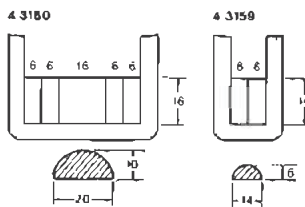

- 4-3160 Abrazadera para  $\varnothing$  16 mm.
- 4-3159 Abrazadera para  $\varnothing$  16 mm.

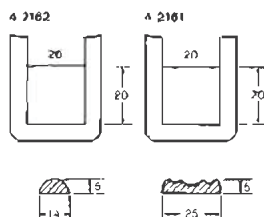

- 4-2162 Abrazadera para  $\varnothing$  20 mm.
- 4-2161 Abrazadera para  $\varnothing$  20 mm.

# Macollas en latón barnizado



4-984-0  
260 x 50 mm.  
Ø 20 mm.



4-985-0  
130 x 50 mm.  
Ø 20 mm.



4-988-0  
M: 260 x 50 mm.  
Ø 20 mm.



4-989-0  
130 x 50 mm.  
Ø 20 mm.



4-990-0  
290 x 54 mm.  
Ø 16 mm.



4-991-0  
145 x 54 mm.  
Ø 16 mm.



4-992-0  
210 x 50 mm.  
Ø 16 mm.



4-1000-0  
140 x 40 mm.  
Ø 16 mm.



4-1002-0  
78 x 40 mm.  
Ø 16 mm.



4-1004-0  
125 x 38 mm.  
Ø 16 mm.



4-1005-0  
80 x 38 mm.  
Ø 16 mm.



4-1007-0  
110 x 30 mm.  
Ø 16 mm.



4-1009-0  
35 x 35 mm.  
Ø 16 mm.



4-1011-0  
38 x 38 mm.  
Ø 16 mm.

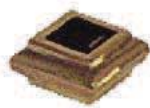

4-1013-0  
35 x 35 mm.  
Ø 16 mm.



4-1017-0  
40 x 18 mm.  
Ø 16 mm.



4-1030-0  
85 x 85 mm.



4-1046-0  
380 x 210 mm.



4-1150-0  
140 mm.



4-2011-0  
155 x 50 mm.  
Ø 16 mm.



4-2012-0  
60 x 40 mm.  
Ø 16 mm.



4-1152-0  
240 mm.



4-2020-0  
140 x 40 mm.  
Ø 16 mm.



4-2021-0  
80 x 40 mm.  
Ø 16 mm.

## Bolas y terminales en latón barnizado



- Bolas pie con rosca**
- 4-4145 Pie simple. Altura: 55 mm. Ø 45 mm. Rosca M8
  - 4-4155 Pie simple. Altura: 67 mm. Ø 55 mm. Rosca M8
  - 4-4165 Pie simple. Altura: 82 mm. Ø 65 mm. Rosca M8
  - 4-4175 Pie simple. Altura: 100 mm. Ø 75 mm. Rosca M10
  - 4-4185 Pie simple. Altura: 110 mm. Ø 85 mm. Rosca M10
  - 4-4195 Pie simple. Altura: 120 mm. Ø 95 mm. Rosca M10
  
  - 4-4140 Pie doble. Altura: 60 mm. Ø 40 mm. Rosca M8
  - 4-4150 Pie doble. Altura: 75 mm. Ø 50 mm. Rosca M8
  - 4-4166 Pie doble. Altura: 90 mm. Ø 60 mm. Rosca M10



- Bolas sin pie con agujero**
- 4-4345 Agujero rosca. Ø 45 mm. Rosca M8
  - 4-4355 Agujero rosca. Ø 55 mm. Rosca M8
  - 4-4365 Agujero rosca. Ø 65 mm. Rosca M8



- 4-4271 Piña 70 x 100 mm. M10
- 4-4261 Piña 60 x 100 mm. M10
- 4-4245 Piña 45 x 80 mm. M10



- Bellotas pie con rosca**
- 4-4240 Pie simple. Altura: 75 mm. Ø 40 mm. Rosca M8
  - 4-4250 Pie simple. Altura: 90 mm. Ø 50 mm. Rosca M8
  - 4-4260 Pie simple. Altura: 110 mm. Ø 60 mm. Rosca M10



- Terminales con rosca**
- 4-4270 Bellota pie simple. Altura: 42 mm. Rosca 10/150
  - 4-4272 Punta pie simple. Altura: 45 mm. Rosca 10/150
  - 4-4274 Botón pie simple. Altura: 30 mm. Rosca 10/150

## Bolas, macollas y elementos en Acero Inox. A-316



**4-4340**  
Ø 40 mm. M10  
**4-4365.1**  
Ø 65 mm. M10  
**4-4380**  
Ø 80 mm. M10



**4-7016**  
Macolla inox.  
25 x 30 mm.  
Para Ø 16 mm.

**4-7018**  
Macolla inox.  
25 x 30 mm.  
Para Ø 18 mm.



**4-7171**  
Soporte Inox A-316



**4-4140.1**  
Ø 40 mm. M10  
**4-4166.1**  
Ø 65 mm. M10  
**4-4180**  
Ø 80 mm. M10



**4-7017.16**  
Macolla inox.  
25 x 30 mm.  
Para Ø 16 mm.

**4-7017.1.16**  
Macolla inox.  
31 x 30 mm.  
Para Ø 16 mm.

**4-7017.18**  
Macolla inox.  
25 x 30 mm.  
Para Ø 18 mm.

**4-7017.1.18**  
Macolla inox.  
31 x 30 mm.  
Para Ø 18 mm.

**4-7173**  
Soporte Inox A-316  
(con tapa)



**4-7661**  
Soporte "Dalia" Inox A-316

\* Fabricación bajo pedido

## Barrotes y pasamanos en Acero Inox. A-316



**4-7965**  
Ø 14  
L: 900 mm.



**4-7966**  
Ø 14  
L: 900 mm.



**4-7000**  
1000 x 80 mm.



**4-7201**  
12 x 900 mm  
**4-7203**  
15 x 900 mm



**4-7202**  
12 x 900 mm  
**4-7204**  
15 x 900 mm



**4-7050**  
53 x 18 mm. aprox.



**4-7054**  
40 x 8 mm "Cantos"  
**4-7053**  
40 x 8 mm "Cruz"  
**4-7052**  
40 x 8 mm "Flor"

\* Fabricación bajo pedido